

ONKYO®

**Super Audio CD &
DVD Audio/Video player**

DV-SP502/ DV-SP502E

Instruction Manual

Thank you for purchasing the Onkyo DV-SP502/
DV-SP502E Super Audio CD & DVD Audio/
Video player. Read this manual carefully before
using your new DVD Player. A good understand-
ing of its features and operation will allow you to
achieve optimum performance and enjoyment.

Keep this manual for future reference.

Contents

Overview	2
Connections	18
Getting Started and Setting up	25
Basic Playback	26
Playback Techniques	30
Detailed Settings	43
Miscellaneous information	54



WARNING:

TO REDUCE THE RISK OF FIRE OR ELECTRIC SHOCK, DO NOT EXPOSE THIS APPARATUS TO RAIN OR MOISTURE.

CAUTION:

TO REDUCE THE RISK OF ELECTRIC SHOCK, DO NOT REMOVE COVER (OR BACK). NO USER-SERVICEABLE PARTS INSIDE. REFER SERVICING TO QUALIFIED SERVICE PERSONNEL.



The lightning flash with arrowhead symbol, within an equilateral triangle, is intended to alert the user to the presence of uninsulated "dangerous voltage" within the product's enclosure that may be of sufficient magnitude to constitute a risk of electric shock to persons.



The exclamation point within an equilateral triangle is intended to alert the user to the presence of important operating and maintenance (servicing) instructions in the literature accompanying the appliance.

Important Safety Instructions

1. Read these instructions.
2. Keep these instructions.
3. Heed all warnings.
4. Follow all instructions.
5. Do not use this apparatus near water.
6. Clean only with dry cloth.
7. Do not block any ventilation openings. Install in accordance with the manufacturer's instructions.
8. Do not install near any heat sources such as radiators, heat registers, stoves, or other apparatus (including amplifiers) that produce heat.
9. Do not defeat the safety purpose of the polarized or grounding-type plug. A polarized plug has two blades with one wider than the other. A grounding type plug has two blades and a third grounding prong. The wide blade or the third prong are provided for your safety. If the provided plug does not fit into your outlet, consult an electrician for replacement of the obsolete outlet.
10. Protect the power cord from being walked on or pinched particularly at plugs, convenience receptacles, and the point where they exit from the apparatus.
11. Only use attachments/accessories specified by the manufacturer.
12. Use only with the cart, stand, tripod, bracket, or table specified by the manufacturer, or sold with the apparatus. When a cart is used, use caution when moving the cart/apparatus combination to avoid injury from tip-over.
13. Unplug this apparatus during lightning storms or when unused for long periods of time.
14. Refer all servicing to qualified service personnel. Servicing is required when the apparatus has been damaged in any way, such as power-supply cord or plug is damaged, liquid has been spilled or objects have fallen into the apparatus, the apparatus has been exposed to rain or moisture, does not operate normally, or has been dropped.

PORTABLE CART WARNING



S3125A

15. Damage Requiring Service
Unplug the apparatus from the wall outlet and refer servicing to qualified service personnel under the following conditions:
A. When the power-supply cord or plug is damaged,
B. If liquid has been spilled, or objects have fallen into the apparatus,
C. If the apparatus has been exposed to rain or water,
D. If the apparatus does not operate normally by following the operating instructions. Adjust only those controls that are covered by the operating instructions as an improper adjustment of other controls may result in damage and will often require extensive work by a qualified technician to restore the apparatus to its normal operation,
E. If the apparatus has been dropped or damaged in any way, and
F. When the apparatus exhibits a distinct change in performance this indicates a need for service.
16. Object and Liquid Entry
Never push objects of any kind into the apparatus through openings as they may touch dangerous voltage points or short-out parts that could result in a fire or electric shock.
The apparatus shall not be exposed to dripping or splashing and no objects filled with liquids, such as vases shall be placed on the apparatus.
Don't put candles or other burning objects on top of this unit.
17. Batteries
Always consider the environmental issues and follow local regulations when disposing of batteries.
18. If you install the apparatus in a built-in installation, such as a bookcase or rack, ensure that there is adequate ventilation.
Leave 20 cm (8") of free space at the top and sides and 10 cm (4") at the rear. The rear edge of the shelf or board above the apparatus shall be set 10 cm (4") away from the rear panel or wall, creating a flue-like gap for warm air to escape.

Precautions

This unit contains a semiconductor laser system and is classified as a "CLASS 1 LASER PRODUCT". So, to use this model properly, read this Instruction Manual carefully. In case of any trouble, please contact the store where you purchased the unit.

To prevent being exposed to the laser beam, do not try to open the enclosure.

DANGER:

VISIBLE AND INVISIBLE LASER RADIATION WHEN OPEN AND INTERLOCK FAILED OR DEFEATED. DO NOT STARE INTO BEAM.

CAUTION:

THIS PRODUCT UTILIZES A LASER. USE OF CONTROLS OR ADJUSTMENTS OR PERFORMANCE OF PROCEDURES OTHER THAN THOSE SPECIFIED HEREIN MAY RESULT IN HAZARDOUS RADIATION EXPOSURE.

The label on the right is applied on the rear panel except for USA and Canadian models.



1. This unit is a CLASS 1 LASER PRODUCT and employs a laser inside the cabinet.
2. To prevent the laser from being exposed, do not remove the cover. Refer servicing to qualified personnel.

For U.S. model

The laser is covered by a housing which prevents exposure during operation or maintenance. However, this product is classified as a Laser Product by CDRH (Center for Devices and Radiological Health) which is a department of the Food and Drug Administration. According to their regulations 21 CFR section 1002.30, all manufactures who sell Laser Products must maintain records of written communications between the manufacturer, dealers and customers concerning radiation safety. If you have any complaints about instructions or explanations affecting the use of this product, please feel free to write to the address on the back page of this manual. When you write us, please include the model number and serial number of your unit.

In compliance with Federal Regulations, the certification, identification and the period of manufacture are indicated on the rear panel.

FCC INFORMATION FOR USER

CAUTION:

The user changes or modifications not expressly approved by the party responsible for compliance could void the user's authority to operate the equipment.

NOTE:

This equipment has been tested and found to comply with the limits for a Class B digital device, pursuant to Part 15 of the FCC Rules.

These limits are designed to provide reasonable protection against harmful interference in a residential installation. This equipment generates, uses and can radiate radio frequency energy and, if not installed and used in accordance with the instructions, may cause harmful interference to radio communications. However, there is no guarantee that interference will not occur in a particular installation.

If this equipment does cause harmful interference to radio or television reception, which can be determined by turning the equipment off and on, the user is encouraged to try to correct the interference by one or more of the following measures:

- Reorient or relocate the receiving antenna.
- Increase the separation between the equipment and receiver.
- Connect the equipment into an outlet on a circuit different from
- that to which the receiver is connected.
- Consult the dealer or an experienced radio/TV technician for help.

Precautions—Continued

For Canadian model

NOTE: This class B digital apparatus complies with Canadian ICES-003.

For models having a power cord with a polarized plug:

CAUTION: TO PREVENT ELECTRIC SHOCK, MATCH WIDE BLADE OF PLUG TO WIDE SLOT, FULLY INSERT.

Modèle pour les Canadien

REMARQUE: Cet appareil numérique de la classe B est conforme à la norme NMB-003 du Canada.

Sur les modèles dont la fiche est polarisée:

ATTENTION: POUR ÉVITER LES CHOCS ÉLECTRIQUES, INTRODUIRE LA LAME LA PLUS LARGE DE LA FICHE DANS LA BORNE CORRESPONDANTE DE LA PRISE ET POUSSER JUSQU'AU FOND.

For British models

Replacement and mounting of an AC plug on the power supply cord of this unit should be performed only by qualified service personnel.

IMPORTANT

The wires in the mains lead are coloured in accordance with the following code:

Blue: Neutral

Brown: Live

As the colours of the wires in the mains lead of this apparatus may not correspond with the coloured markings identifying the terminals in your plug, proceed as follows:

The wire which is coloured blue must be connected to the terminal which is marked with the letter N or coloured black.

The wire which is coloured brown must be connected to the terminal which is marked with the letter L or coloured red.

IMPORTANT

A 3, 5 or 13 ampere fuse is fitted in this plug. Should the fuse need to be replaced, please ensure that the replacement fuse has a rating of 3, 5 or 13 amperes and that it is approved by ASTA or BSI to BS1362. Check for the ASTA mark or the BSI mark on the body of the fuse. **IF THE FITTED MOULDED PLUG IS UNSUITABLE FOR THE SOCKET OUTLET IN YOUR HOME THEN THE FUSE SHOULD BE REMOVED AND THE PLUG CUT OFF AND DISPOSED OF SAFELY. THERE IS A DANGER OF SEVERE ELECTRICAL SHOCK IF THE CUT OFF PLUG IS INSERTED INTO ANY 13 AMPERE SOCKET.**

If in any doubt, consult a qualified electrician.

For European Models

Declaration of Conformity

We, ONKYO EUROPE
ELECTRONICS GmbH
LIEGNITZERSTRASSE 6,
82194 GROEBENZELL,
GERMANY



declare in own responsibility, that the ONKYO product described in this instruction manual is in compliance with the corresponding technical standards such as EN60065, EN55013, EN55020 and EN61000-3-2, -3-3.

GROEBENZELL, GERMANY

I. MORI

ONKYO EUROPE ELECTRONICS GmbH

1. Region Numbers

The DVD standard uses region numbers to control how discs can be played around the world, the world being divided into six regions. This unit will only play DVD discs that match its region number, which can be found on its rear panel (e.g.,).

2. About this Manual

This manual explains how to use all of this unit's functions. Although the DVD standard offers many special features, not all discs use them all, so depending on the disc being played, this unit may not respond to certain functions. See the disc's sleeve notes for supported features.

When you attempt to use a DVD feature that is not available, this logo may appear onscreen, indicating that the feature is not supported by the current disc or this unit.

3. Recording Copyright

Unless it's for personal use only, recording copyrighted material is illegal without the permission of the copyright holder.

4. Power

WARNING

BEFORE PLUGGING IN THE UNIT FOR THE FIRST TIME, READ THE FOLLOWING SECTION CAREFULLY.

AC outlet voltages vary from country to country. Make sure that the voltage in your area meets the voltage requirements printed on this unit's rear panel (e.g., AC 120 V, 60 Hz).

Precautions—Continued

5. Never Touch this Unit with Wet Hands

Never handle this unit or its power cord while your hands are wet or damp. If water or any other liquid gets inside this unit, have it checked by your Onkyo dealer.

6. Installing this Unit

- Install this unit in a well-ventilated location. Ensure that there's adequate ventilation all around this unit, especially if it's installed in an audio rack. If the ventilation is inadequate, the unit may overheat, leading to malfunction.
- Do not expose this unit to direct sunlight or heat sources, because its internal temperature may rise, shortening the life of the optical pickup.
- Avoid damp and dusty places, and places subject to vibrations from loudspeakers. Never put the unit on top of, or directly above a loudspeaker.
- Install this unit horizontally. Never use it on its side or on a sloping surface, because it may cause a malfunction.
- If you install this unit near a TV, radio, or VCR, the picture and sound quality may be affected. If this occurs, move this unit away from the TV, radio, or VCR.

7. Care

Occasionally, you should dust this unit all over with a soft cloth. For stubborn stains, use a soft cloth dampened with a weak solution of mild detergent and water. Dry the unit immediately afterwards with a clean cloth. Do not use abrasive cloths, thinners, alcohol, or other chemical solvents, because they may damage the finish or remove the panel lettering.

8. Handling Notes

- If you need to transport this unit, use the original packaging to pack it how it was when you originally bought it.
- Do not use volatile liquids, such as insect sprays, near this unit. Do not leave rubber or plastic items on this unit for a long time, because they may leave marks on the case.
- This unit's top and rear panels may get warm after prolonged use. This is normal.
- When you've finished using this unit, remove all discs and turn off the power.
- If you do not use this unit for a long time, it may not work properly the next time you turn it on, so be sure to use it occasionally.

9. To Obtain a Clear Picture

This unit is a high-tech, precision device. If the lens on the optical pickup, or the disc drive mechanism becomes dirty or worn, the picture quality may be affected. To maintain the best picture quality, we recommend regular inspection and maintenance (cleaning or worn part replacement) every 1,000 hours of use depending on the operating environment. Contact your Onkyo dealer for details.

10. Moisture Condensation

Moisture condensation may damage this unit.

Read the following carefully:

When you take a glass containing a cold drink outside on a summer's day, drops of water, called condensation, form on the outside of the glass. Similarly, moisture may condense on the lens of the optical pickup, one of the most important parts inside this unit.

- Moisture condensation can occur in the following situations:
 - The unit is moved from a cold place to a warm place.
 - A heater is turned on, or cold air from an air conditioner is hitting the unit.
 - In the summer, when this unit is moved from an air conditioned room to a hot and humid place.
 - The unit is used in a humid place.
- Do not use this unit when there's the possibility of moisture condensation occurring. Doing so may damage your discs and certain parts inside this unit. If condensation does occur, remove all discs and leave this unit turned on for two to three hours. By this time, the unit will have warmed up and any condensation will have evaporated. To reduce the risk of condensation, keep this unit connected to a wall outlet.

Table of Contents

Basic Operation

Overview

Important Safety Instructions.....	2
Precautions	3
Introduction.....	7
DV-SP502/DV-SP502E Features	7
Supplied Accessories	8
Disc Notes	9
Before Using the DV-SP502/DV-SP502E	11
Installing the Batteries	11
Using the Remote Controller	11
Front & Rear Panels.....	12
Front Panel.....	12
Display.....	13
Rear Panel.....	14
Rear Panel.....	15
Remote Controller	16

Connections

Connecting the DV-SP502/DV-SP502E.....	18
Before Making Any Connections	18
AV Cables & Connectors.....	18
Basic Setup	19
Connecting Your TV	20
Connecting to an AV Receiver	22
Connecting RI -compatible Components....	23
Connecting the Power/Turning on the DV-SP502/DV-SP502E	24

Getting Started and Setting up

Getting Started	25
Using the on-screen displays	25
Setting up the player for your TV.....	25
Setting the language of this player's on-screen displays	26

Basic Playback

Playing discs.....	26
Basic playback controls	27
Resume and Last Memory	28
DVD disc menus.....	28
Video CD PBC menus	29

Advanced Operation

Playback Techniques

Playing discs.....	30
Scanning discs	30
Playing in slow motion.....	30
Frame advance/frame reverse.....	31
Viewing a JPEG slideshow	31
Browsing video content with the Disc Navigator	32
Browsing WMA, MP3 and JPEG files with the Disc Navigator	33
Looping a section of a disc.....	34
Using repeat play	34
Using random play	35
Creating a program list.....	36
Other functions available from the program menu.....	37
Searching a disc.....	37
Switching subtitles.....	38
Switching audio language/channel.....	38
Zooming the screen	39
Switching camera angles	39
Displaying disc information	39
DivX® video playback on the DV-SP502/ DV-SP502E (not North American model).....	40
About DivX	40
Playing DivX video	40
About DivX® VOD content.....	42
Playing DivX® VOD content	42

Detailed Settings

Audio Settings and Video Adjust menus.....	43
Audio Settings menu	43
Audio DRC	43
Video Adjust menu	44
Initial Settings menu.....	45
Using the Initial Settings menu.....	45
Digital Audio Out settings.....	46
Video Output settings.....	46
Language settings.....	47
Display settings	47
Options settings	48
Speakers settings.....	48
About the audio output settings.....	49
Parental Lock	50
Registering a new password	50
Changing your password	50
Setting/changing the Parental Lock	50
Setting/changing the Country code	51
Country code list	51
DTS Downmix	52
Audio Output Mode	52
Speaker Installation.....	52
Speaker Distance.....	53

Table of Contents—Continued

Miscellaneous information

Additional information	54
Screen sizes and disc formats	54
Setting the TV system (Not North American model)	54
Resetting the player	55
Titles, chapters and tracks	55
DVD-Video regions	55
Selecting languages using the language code list	56
Language code list	57
Using the Remote controller with Other Brand's TVs (North American model only)	58
DivX Titles	60
Glossary	62
FAQ	63
Troubleshooting	64
DV-SP502/DV-SP502E	64
Remote Controller	66
Specifications	67

Introduction

DV-SP502/DV-SP502E Features

Highlights

- Dolby¹ Digital and DTS²
- DVD-Video / Video CD / Audio CD playback
- CD-R, CD-RW (Video CD, audio CD, MP3/WMA³/JPEG)
- DVD-Audio and SACD compatible
- Super VCD compatible
- DVD-R (DVD-Video)
- DVD-RW (DVD-Video, VR format)
- 5.1-channel analog audio output

Video

- Advanced 108 MHz/12-bit video D/A converter
- Component video output
- S-Video and composite video outputs
- Frame-by-frame playback
- Slow motion playback
- Fast forward and reverse
- Repeat playback
- Random playback
- Supports 4:3 and 16:9 aspect ratio TVs
- Multiple camera angle support
- Parental Lock function
- Screen Saver function

Audio

- 192 kHz/24-bit D/A converter
- Optical / Coaxial digital output

Others

- Dynamic Range Control setting
- Adjustable display brightness
- Full-function remote controller

The letter displayed at the end of the product name found in catalogs and on package represents the color of the DV-SP502/DV-SP502E. Though the color varies, the specifications and operations are the same.

1. Manufactured under license from Dolby Laboratories. "Dolby" and the double-D symbol are trademarks of Dolby Laboratories.
2. "DTS" and "DTS Digital Out" are trademarks of Digital Theater Systems, Inc.
3. Windows Media, and the Windows logo are trademarks, or registered trademarks of Microsoft Corporation in the United States and/or other countries.



Introduction—Continued

Supplied Accessories

Make sure you have the following accessories:

RC-574DV
(Other model)

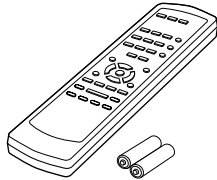

RC-582DV
(North American model)

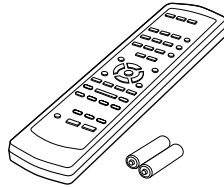

Remote controller & 2 batteries (AA)

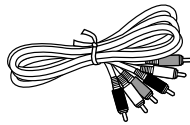

AV cable (RCA) (1.5 m)



S-Video cable (1.5 m)

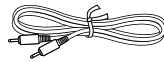

RI cable (0.8 m)

This cable is used to connect the DV-SP502/DV-SP502E to other **RI**-compatible Onkyo components for **RI** (Remote Interactive) control.

To use **RI**, in addition to an **RI** connection, you must make an analog audio connection (RCA) between the DV-SP502/DV-SP502E and your Onkyo AV receiver.

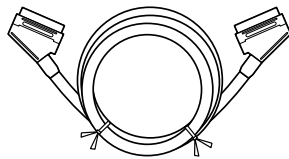

SCART cable (1.5 m) (European models only)

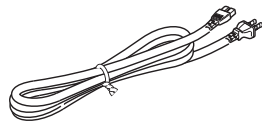

Power cord (2 m)

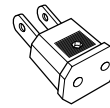

Power-plug adapter









Only supplied in certain countries. Use this adapter if your AC outlet does not match with the plug on the DV-SP502/DV-SP502E's power cord. (Adapter varies from country to country.)

Introduction—Continued

Disc Notes

Supported Discs

The DV-SP502/DV-SP502E supports the following discs.

Disc	Logo	Format or file type
DVD-Video		See page 55 for region information.
DVD-Audio		DVD-Audio
SACD		Super Audio CD (single layer, dual layer, hybrid)
DVD-R		DVD-Video
DVD-RW		DVD-Video, VR format
Video CD		Including PBC
Audio CD		PCM and DTS
CD-R		Video CD, audio CD, MP3, WMA, JPEG
CD-RW		Video CD, audio CD, MP3, WMA, JPEG
JPEG CD		JPEG

- Some audio CDs feature copy protection that doesn't conform to the official CD standard. Since these are nonstandard discs, they may not play properly in the DV-SP502/DV-SP502E.
- The DV-SP502/DV-SP502E supports CD-R and CD-RW discs recorded in Video CD format, audio CD format, or ISO 9660 Level 1 or 2 format with MP3, WMA, and JPEG files. It also supports DVD-R and DVD-RW discs recorded in DVD-Video format. However, some CD-R, CD-RW, DVD-R, and DVD-RW discs may not work properly for any of the following reasons: incomplete disc finalization, disc burner characteristics, disc characteristics, the disc is damaged or dirty. See the manual supplied with your disc burner for more information. Condensation or dirt on the optical pickup lens can also affect playback.
- The DV-SP502/DV-SP502E supports 8 cm and 12 cm discs.
- The DV-SP502/DV-SP502E does not support disc types not listed.

- Don't use discs with an unusual shape, such as those shown below, because you may damage the DV-SP502/DV-SP502E.



- Don't use discs that have residue from adhesive tape, rental discs with peeling labels, or discs with custom-made labels or stickers. Doing so may damage the DV-SP502/DV-SP502E and you may not be able to remove the disc properly.

Discs Made on Personal Computers

Discs made on personal computers, including those of a compatible format, may not work properly in the DV-SP502/DV-SP502E because of incorrect settings in the disc burning software. Check the manuals supplied with your disc burning software for additional compatibility information.

CD-R/RW compatibility

- Compatible formats: CD-Audio, Video CD, ISO 9660 CD-ROM* containing MP3, WMA or JPEG files
 - * ISO 9660 Level 1 or 2 compliant. CD physical format: Mode1, Mode2 XA Form1. Romeo and Joliet file systems are both compatible with this player.
- Multi-session playback: No
- Unfinalized disc playback: No

DVD-R/RW compatibility

- Compatible formats: DVD-Video, Video Recording (VR)*
 - * Edit points may not play exactly as edited; screen may go momentarily blank at edited points.
- Unfinalized playback: No
- WMA/MP3/JPEG file playback on DVD-R/RW: No

Compressed audio compatibility

- Compatible formats: MPEG-1 Audio Layer 3 (MP3), Windows Media Audio (WMA)
- Sampling rates: 32, 44.1 or 48kHz
- Bit-rates: Any (128Kbps or higher recommended)
- VBR (variable bit rate) MP3 playback: No
- VBR WMA playback: No
- WMA lossless encoding compatible: No
- DRM (Digital Rights Management) compatible: Yes (DRM-protected audio files will not play in this player—see also DRM in the “Glossary” on page 62)
- File extensions: .mp3, .wma (these must be used for the player to recognize MP3 and WMA files – do not use for other file types)
- File structure: Up to 299 folders; up to 648 folders and files combined

Introduction—Continued

About WMA

WMA is an acronym for Windows Media Audio and refers to an audio compression technology developed by Microsoft Corporation. WMA content can be encoded by using Windows Media® Player version 7, 7.1, Windows Media® Player for Windows® XP, or Windows Media® Player 9 Series.

JPEG file compatibility

- Compatible formats: Baseline JPEG and EXIF 2.2* still image files up to a resolution of 3072 x 2048.
* File format used by digital still cameras
- Progressive JPEG compatible: No
- File extensions: .jpg (must be used for the player to recognize JPEG files – do not use for other file types)
- File structure: Up to 299 folders; up to 648 folders and files combined

PC-created disc compatibility

Discs recorded using a personal computer may not be playable in this unit due to the setting of the application software used to create the disc. In these particular instances, check with the software publisher for more detailed information.

Discs recorded in packet write mode (UDF format) are not compatible with this player.

Check the DVD-R/RW or CD-R/RW software disc boxes for additional compatibility information.

Copyright

It is forbidden by law to copy, broadcast, show, broadcast on cable, play in public, or rent copyrighted material without permission.

DVD-Video discs are copy-protected, and any recordings made from these discs will be distorted.

This product incorporates copyright protection technology that is protected by method claims of certain U.S. patents and other intellectual property rights owned by Macrovision Corporation and other rights owners. Use of this copyright-protection technology must be authorized by Macrovision Corporation, and is intended for home and other limited viewing uses only, unless otherwise authorized by Macrovision Corporation. Reverse engineering or disassembly is prohibited.

Handling Discs

- Never touch the underside of a disc. Always hold discs by the edge, as shown.

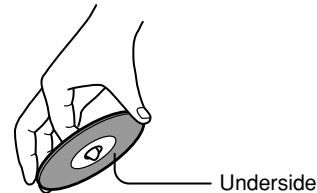

- Never attach adhesive tape or sticky labels to discs.



Cleaning Discs

- For best results, keep your discs clean. Fingerprints and dust can affect the sound and picture quality and should be removed as follows. Using a clean soft cloth, wipe from the center outwards, as shown. Never wipe in a circular direction.



- To remove stubborn dust or dirt, wipe the disc with a damp soft cloth, and then dry it with a dry cloth.
- Never use solvent-based cleaning fluids, such as thinner or benzene, commercially available cleaners, or antistatic sprays intended for vinyl records, because they may damage the disc.

Storing Discs

- Don't store discs in places subject to direct sunlight, or near heat sources.
- Don't store discs in places subject to moisture or dust, such as in a bathroom or near a humidifier.
- Always store discs in their cases and vertically. Stacking, or putting objects on unprotected discs may cause warping, scratches, or other damage.

Before Using the DV-SP502/DV-SP502E

Installing the Batteries

1 Open the battery compartment, as shown.

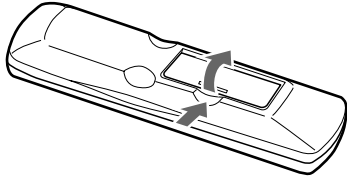

2 Insert the two supplied batteries (AA) in accordance with the polarity diagram inside the battery compartment.

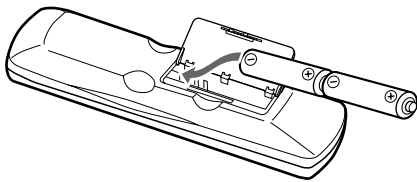

3 Close the battery compartment.

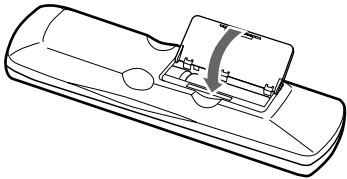

Notes:

- The supplied batteries should last for about six months, although this will vary with usage.
- If the remote controller doesn't work reliably, try replacing both batteries.
- Don't mix new and old batteries, or different types of batteries.
- If you intend not to use the remote controller for a long time, remove the batteries to prevent possible leakage and corrosion.
- Flat batteries should be removed as soon as possible to prevent possible leakage and corrosion.

Using the Remote Controller

To use the remote controller, point it at the DV-SP502/DV-SP502E's remote control sensor, as shown below.

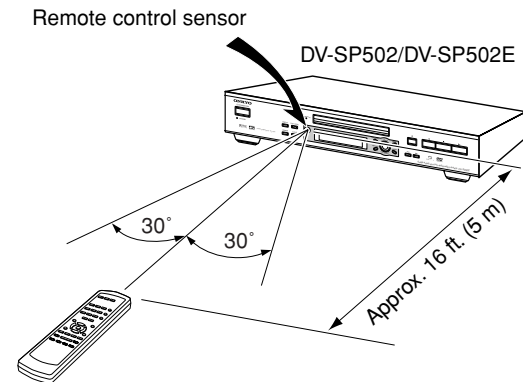

Notes:

- The remote controller may not work reliably if the DV-SP502/DV-SP502E is subjected to bright light, such as direct sunlight or inverter-type fluorescent lights. Keep this in mind when installing the DV-SP502/DV-SP502E.
- If another remote controller of the same type is used in the same room, or the DV-SP502/DV-SP502E is installed close to equipment that uses infrared rays, the remote controller may not work reliably.
- Don't put anything, such as a book, on the remote controller, because the buttons may be pressed inadvertently, thereby draining the batteries.
- The remote controller may not work reliably if the DV-SP502/DV-SP502E is installed in a rack behind colored glass doors. Keep this in mind when installing the DV-SP502/DV-SP502E.
- The remote controller will not work if there's an obstacle between it and the DV-SP502/DV-SP502E's remote control sensor.

Front & Rear Panels

For detailed information, refer to the pages in brackets.

Front Panel

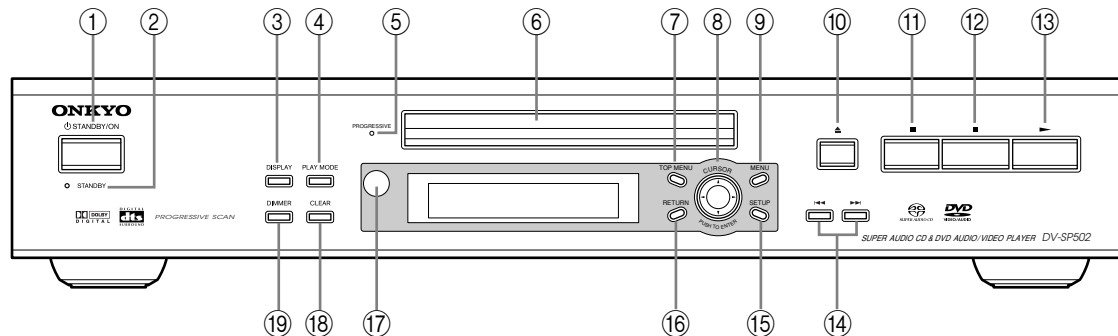





- ① **STANDBY/ON button [24, 26]**
This button is used to set the DV-SP502/DV-SP502E to On or Standby.
- ② **STANDBY indicator [24]**
This indicator lights up when the DV-SP502/DV-SP502E is in Standby.
- ③ **DISPLAY button [39]**
This button is used to display information about the current disc, title, chapter, or track, including the elapsed time, remaining time, total time, and so on. Press it repeatedly to display more information.
- ④ **PLAY MODE button [34–37]**
This button is used to open and close the Play Mode menu.
- ⑤ **PROGRESSIVE indicator [20, 46]**
This indicator lights up when the DV-SP502/DV-SP502E is set to output progressive scan video.
- ⑥ **Disc tray [26]**
Discs are loaded here.
- ⑦ **TOP MENU button [28]**
This button is used to display the top menu of a DVD-Video disc.
- ⑧ **Cursor ◀/▶/▲/▼ & ENTER buttons [25]**
The four cursor buttons located around the central [ENTER] button are used to navigate DVD-Video menus and the onscreen setup menus. The central [ENTER] button is used to start playback of the selected title, chapter, or track and to confirm settings.
- ⑨ **MENU button [28]**
This button is used to display a menu on a DVD-Video disc or to open the Disc Navigator when using a Video CD, audio CD, WMA/MP3/JPEG disc, or VR format DVD-RW disc.
- ⑩ **▲ (open/close) button [26]**
This button is used to open and close the disc tray.
- ⑪ **▬▬ (pause) button [27]**
This button is used to pause playback.
- ⑫ **■ (stop) button [27]**
This button is used to stop playback.
- ⑬ **▶ (play) button [26, 27]**
This button is used to start playback.
- ⑭ **Previous/Next ◀◀/▶▶ buttons [27]**
The Previous button is used to select the previous chapter or track. During playback it selects the beginning of the current chapter or track. The Next button is used to select the next chapter or track.
- ⑮ **SETUP button [25]**
This button is used to open and close the onscreen setup menus.
- ⑯ **RETURN button [25, 28]**
This button is used to return to the main menu without saving your changes.
- ⑰ **Remote control sensor [11]**
This sensor receives control signals from the remote controller.
- ⑱ **CLEAR button [36]**
This button is used to cancel various functions.
- ⑲ **DIMMER button**
This button is used to adjust the display brightness.

→ normal → dim → dimmer →

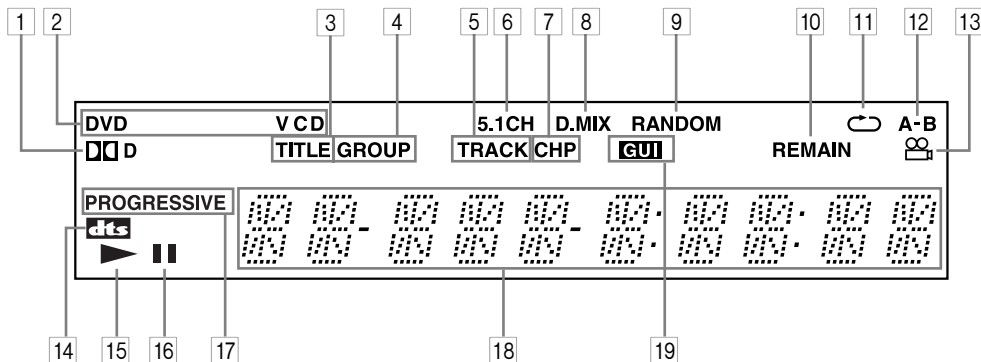
Front & Rear Panels—Continued

Display



- 1 **Dolby Digital (D) indicator**
This indicator appears when playing Dolby Digital material.
- 2 **Disc type indicators**
These indicators show the type of disc loaded.
- 3 **TITLE indicator**
While stopped, the total number of titles on the current DVD-Video disc is displayed here. During playback, the number of the current title is displayed.
- 4 **GROUP indicator**
While stopped, the total number of groups on the current DVD-Audio disc is displayed here. During playback, the number of the current group is displayed.
- 5 **TRACK indicator**
This indicator appears while track numbers are being displayed. While stopped, the total number of tracks on the current SACD, Video CD, audio CD, or MP3/WMA disc are displayed. During playback, the number of the current track is displayed.
- 6 **5.1 CH indicator**
This indicator lights up when 5.1-channel analog audio output is selected.
- 7 **CHP indicator**
This indicator appears while the number of the current chapter is being displayed.
- 8 **D.MIX indicator**
During multichannel audio playback, indicates that the output signal has been “downmixed” from the original audio source. This is an automatic function performed by the player in order to present the most appropriate audio mix to the speakers present in your system.
- 9 **RANDOM indicator**
This indicator appears when using the Random function.
- 10 **REMAIN indicator**
This indicator appears while the remaining time is being displayed.
- 11 **Repeat  indicator**
This indicator appears when A-B playback or repeat playback is used.
- 12 **A-B indicator**
These indicators appear when using the A-B Repeat function.
- 13 **Camera angle  indicator**
This indicator appears if the DVD-Video disc being played features multiple camera angles.
- 14 **DTS indicator**
This indicator appears when playing DTS material.
- 15 **Play  indicator**
This indicator is shown during playback.
- 16 **Pause  indicator**
This indicator appears when playback is paused.
- 17 **PROGRESSIVE indicator**
This indicator appears when the Progressive Scanning function is on.
- 18 **Message & time area**
Time information, such as total time, remaining time, and so on, is displayed here in hours, minutes, and seconds. Other messages are also displayed.
- 19 **GUI (Graphical User Interface) indicator**
This indicator appears when the onscreen setup menu is open.

Front & Rear Panels—Continued

Rear Panel

■ Not European model

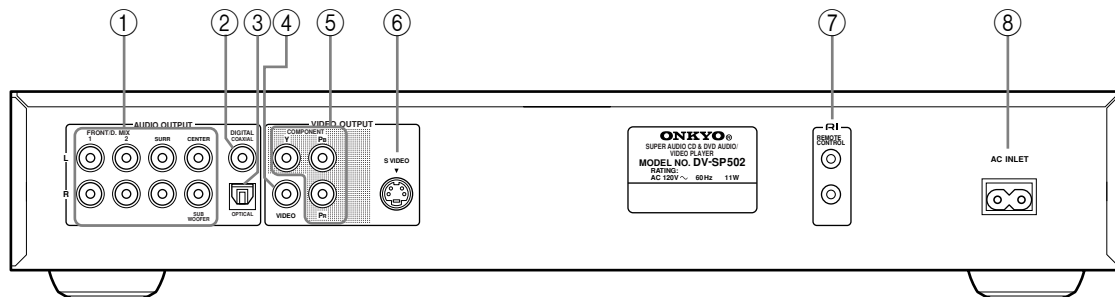

See page 15 for the European model.

① AUDIO OUTPUT [22–23]

These jacks output analog audio. The FRONT/D.MIX jacks can be connected to the stereo input on a TV, hi-fi amp, or other component. The 1 and 2 jacks output the same signals so you can use either. DVDs with 5.1-channel audio are downmixed into two channels before being output by the FRONT/D.MIX jacks.

If you're using an AV receiver or surround decoder with a 5.1-channel analog audio input, use the FRONT/D.MIX 1 or 2 jacks and the SURR L/R, CENTER, and SUBWOOFER jacks. In this case, you must set the Audio Output Mode on the Initial Setup menu to 5.1 Channel. With this setting, the FRONT/D.MIX jacks will output the front signals, and the SURR L/R, CENTER, and SUBWOOFER jacks will output the surround, center, and subwoofer signals respectively.

② COAXIAL DIGITAL AUDIO OUTPUT [22]

This coaxial digital audio output can be connected to a coaxial digital audio input on a hi-fi amp, AV receiver, or surround sound decoder (Dolby Digital, DTS).

③ OPTICAL DIGITAL AUDIO OUTPUT [22]

This optical digital audio output can be connected to an optical digital audio input on a hi-fi amp, AV receiver, or surround sound decoder (Dolby Digital, DTS).

④ VIDEO OUTPUT [19]

This RCA connector can be used to connect a TV or projector with a composite video input.

⑤ COMPONENT VIDEO OUTPUT [20]

These jacks output component video and can be connected to a component video input on a TV or projector.

⑥ S VIDEO OUTPUT [20]

This connector can be used to connect a TV or projector with an S-Video input.

⑦ RI jack [23]

These **RI** (Remote Interactive) connectors can be connected to the **RI** connectors on your other Onkyo AV components for interactive control. Connecting an **RI** cable only does not make the system operational. You must also connect the audio cables as well.

⑧ AC INLET [24]

The supplied power cord is connected here. The other of the power cord should be connected to a suitable wall outlet.

Front & Rear Panels—Continued

Rear Panel

■ European Model

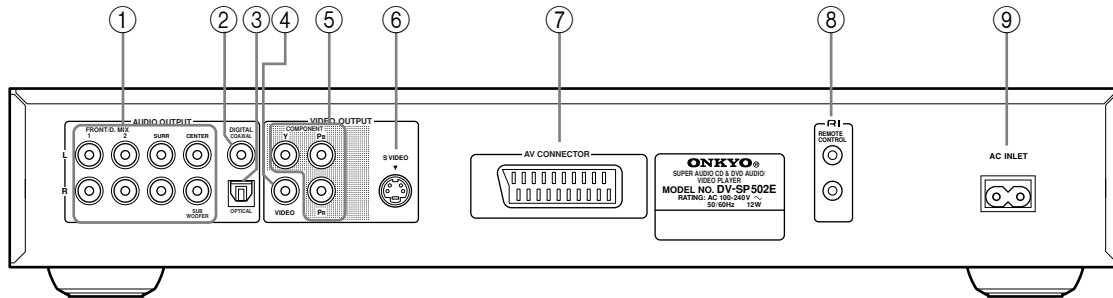

① AUDIO OUTPUT [22–23]

These jacks output analog audio. The FRONT/D.MIX jacks can be connected to the stereo input on a TV, hi-fi amp, or other component. The 1 and 2 jacks output the same signals so you can use either. DVDs with 5.1-channel audio are downmixed into two channels before being output by the FRONT/D.MIX jacks.

If you're using an AV receiver or surround decoder with a 5.1-channel analog audio input, use the FRONT/D.MIX 1 or 2 jacks and the SURR L/R, CENTER, and SUBWOOFER jacks. In this case, you must set the Audio Output Mode on the Initial Setup menu to 5.1 Channel. With this setting, the FRONT/D.MIX jacks will output the front signals, and the SURR L/R, CENTER, and SUBWOOFER jacks will output the surround, center, and subwoofer signals respectively.

② COAXIAL DIGITAL AUDIO OUTPUT [22]

This coaxial digital audio output can be connected to a coaxial digital audio input on a hi-fi amp, AV receiver, or surround sound decoder (Dolby Digital, DTS).

③ OPTICAL DIGITAL AUDIO OUTPUT [22]

This optical digital audio output can be connected to an optical digital audio input on a hi-fi amp, AV receiver, or surround sound decoder (Dolby Digital, DTS).

④ VIDEO OUTPUT [19]

This RCA connector can be used to connect a TV or projector with a composite video input.

⑤ COMPONENT VIDEO OUTPUT [20]

These jacks output component video and can be connected to a component video input on a TV or projector.

⑥ S VIDEO OUTPUT [20]

This connector can be used to connect a TV or projector with an S-Video input.

⑦ AV CONNECTOR [20]

This SCART output can be connected to a TV or projector with a SCART input by using the supplied SCART cable. This SCART connector outputs 2-channel stereo audio, composite video, S-Video, and RGB video.

⑧ RI JACK [23]

These RI (Remote Interactive) connectors can be connected to the RI connectors on your other Onkyo AV components for interactive control. Connecting an RI cable only does not make the system operational. You must also connect the audio cables as well.

⑨ AC INLET [24]

The supplied power cord is connected here. The other of the power cord should be connected to a suitable wall outlet.

Front & Rear Panels—Continued

Remote Controller

■ North American models

■ Other models

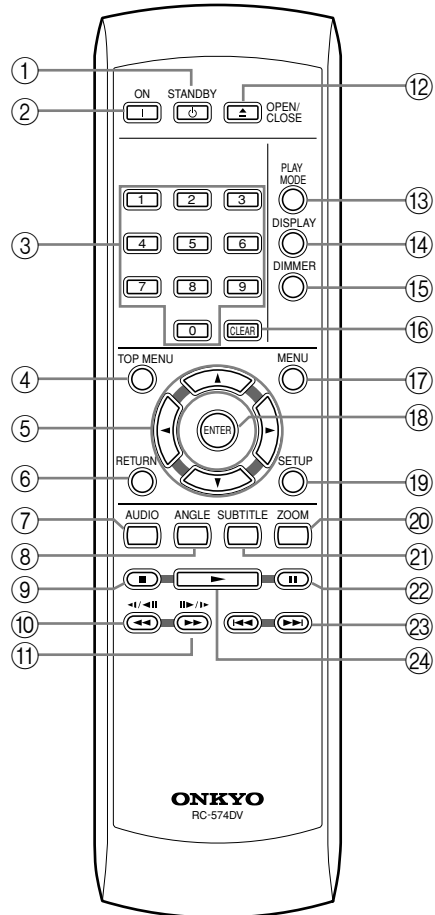
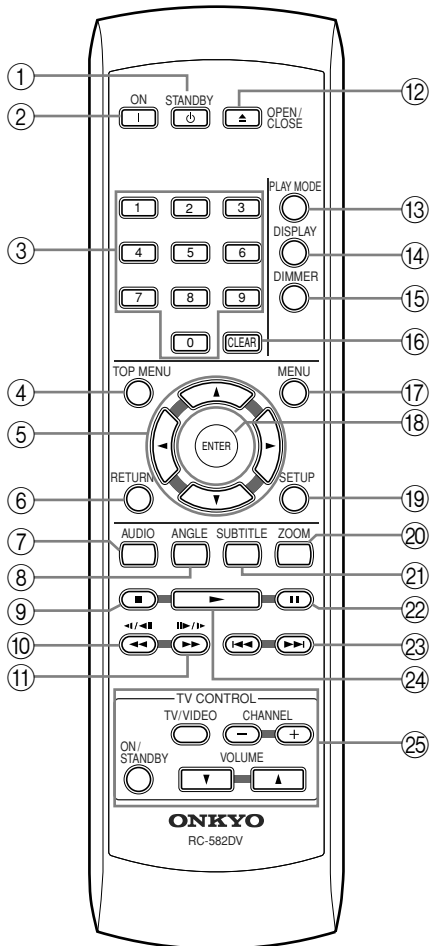

Front & Rear Panels—Continued

- ① **STANDBY button [24]**
This button is used to set the DV-SP502/DV-SP502E to Standby.
- ② **ON button [24]**
This button is used to turn on the DV-SP502/DV-SP502E.
Don't turn on the DV-SP502/DV-SP502E until you've completed, and double checked all connections (pages 18–23).
- ③ **Number buttons [27–29, 37, 50]**
These buttons are used to enter title, chapter, and track numbers and to enter times for locating specific points in time.
- ④ **TOP MENU button [28]**
This button is used to display the top menu on a DVD-Video disc.
- ⑤ **Cursor ◀/▶/▲/▼ buttons [25]**
These buttons are used to navigate onscreen menus.
- ⑥ **RETURN button [25, 28]**
This button is used to return to the main menu without saving your changes.
- ⑦ **AUDIO button [38]**
This button is used to select foreign language soundtracks and audio formats (e.g., Dolby Digital or DTS) on DVD-Video discs.
For Video CDs you can select left-channel, right-channel, or stereo.
- ⑧ **ANGLE button [39]**
This button is used to select camera angles on DVD-Video discs.
- ⑨ **Stop ■ button [27]**
This button is used to stop playback.
- ⑩ **Fast Reverse ◀◀ / (◀◀/◀◀II) button [27, 30, 31]**
This button is used for fast reverse, reverse slow motion, and reverse frame-by-frame playback.
- ⑪ **Fast Forward ▶▶ / (II▶▶/▶▶) button [27, 30, 31]**
This button is used for fast forward, slow motion, and frame-by-frame playback.
- ⑫ **OPEN/CLOSE ▲ button [26]**
This button is used to open and close the disc tray.
- ⑬ **PLAY MODE button [34–37]**
This button is used to open and close the Play Mode menu.
- ⑭ **DISPLAY button [39]**
This button is used to display information about the current disc, title, chapter, or track, including the elapsed time, remaining time, total time, and so on. Press it repeatedly to display more information.
- ⑮ **DIMMER button**
This button is used to adjust the display brightness.
◻ → normal → dim → dimmer ◻
- ⑯ **CLEAR [36]**
This button is used to cancel various functions.
- ⑰ **MENU button [28]**
This button is used to display the menu on a DVD-Video disc or to open the Disc Navigator when using a Video CD, audio CD, WMA/MP3/JPEG disc, or VR format DVD-RW disc.
- ⑱ **ENTER button [25]**
This button is used to start playback of the selected title, chapter, or track, and to confirm settings.
- ⑲ **SETUP button [26, 43–45]**
This button is used to open and close the onscreen setup menus.
- ⑳ **ZOOM button [39]**
This button is used with the Zoom function.
- ㉑ **SUBTITLE button [38]**
This button is used to select subtitles on DVD-Video discs.
- ㉒ **Pause ■■ button [27, 30, 31]**
This button is used to pause playback.
- ㉓ **Previous/Next ◀◀/▶▶ buttons [27]**
The Previous button is used to select the previous chapter or track. During playback it selects the beginning of the current chapter or track.
The Next button is used to select the next chapter or track.
- ㉔ **Play ▶ button [27]**
This button is used to start playback.
- ㉕ **TV Control buttons [58]**
TV/Video button
Used to select TV or VCR on your TV.
Channel -/+ buttons
Used to select channels on your TV.
On/Standby button
Used to set your TV to On or Standby.
Volume ▲/▼ buttons
Used to adjust your TV's volume.

Connecting the DV-SP502/DV-SP502E

Before Making Any Connections

- Read the manuals supplied with your AV components.
- Don't connect the power cord until you've completed all audio and video connections.

Optical Digital Outputs

The DV-SP502/DV-SP502E's optical digital connectors have a shutter-type cover that opens when an optical plug is inserted, and closes when it's removed. Push the plug in all the way.

Caution: To prevent shutter damage, hold the optical plug straight when inserting and removing.

RCA AV Connection Color Coding

RCA AV connections are usually color coded: red, white, and yellow. Use red plugs to connect right-channel audio inputs and outputs (typically labeled "R"). Use

white plugs to connect left-channel audio inputs and outputs (typically labeled "L"). And use yellow plugs to connect composite video inputs and outputs.

The supplied AV cable is made up of an analog audio cable and a composite video cable.

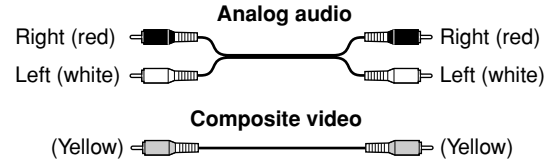

- Push each plug in all the way to make a good connection (loose connections can cause noise or malfunctions).
- To prevent interference, keep audio and video cables away from power cords and speaker cables.

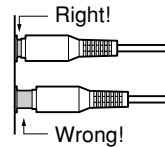

AV Cables & Connectors

Video			
Component video			Component video separates the luminance (Y) and color difference signals (PR, PB), providing the best picture quality. Some TV manufacturers label their component video inputs differently.
S-Video			S-Video provides better picture quality than composite video.
Composite video			Composite video can be found on virtually all TVs, VCRs, and video equipment.
Scart (European model only)			SCART connections carry audio and video (composite, S-Video, RGB) all in one cable.
Audio			
Optical digital			Optical digital audio connections provide better audio quality than analog connections.
Coaxial digital			Coaxial digital audio connections provide better audio quality than analog connections.
Analog			RCA analog audio connectors can be found on virtually all AV components.
Multichannel analog audio cable (RCA)			This cable carries multichannel analog audio and it's typically used to connect DV-SP502/DV-SP502Es with individual 5.1 channel analog audio outputs. Several standard analog audio cables can be used instead of a multichannel cable.

Connecting the DV-SP502/DV-SP502E—Continued

Basic Setup

The setup described here is a basic setup that allows you to play discs using just the cables supplied with the player. In this setup, stereo audio is played through the speakers in your TV.

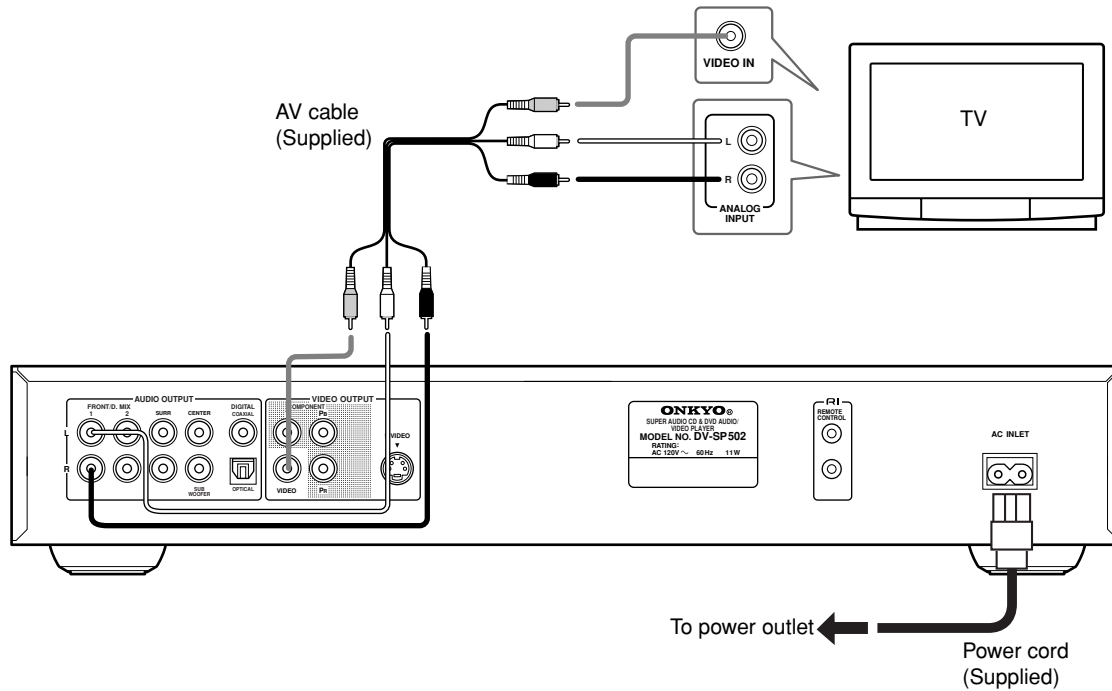

- This player is equipped with copy protection technology. Do not connect this player to your TV via a VCR using AV cables, as the picture from this player will not appear properly on your TV. (This player may also not be compatible with some combination TV/VCRs for the same reason; refer to the manufacturer for more information.)

1. Connect the VIDEO OUTPUT and AUDIO OUTPUT ANALOG L/R jacks to a set of A/V inputs on your TV.

Use the supplied AV cable (RCA), connecting the red and white plugs to the audio outputs and the yellow plug to the video output. Make sure you match up the left and right audio outputs with their corresponding inputs for correct stereo sound.

See the following page if you want to use a component or S Video cable for the video connection.

If you need another pair of stereo outputs (and don't need to use the multichannel analog outputs), you can use the FRONT/D.MIX 1 or 2 AUDIO OUTPUT jacks (page 22).

2. Connect the supplied AC power cord to the AC INLET, then plug into a power outlet.

Notes:

- Before unplugging the player from the power outlet, make sure you first switch it into standby using either the front panel STANDBY/ON button, or the remote controller, and wait of the "GOOD BYE" message to disappear from the player's display.
- For the above reasons, do not plug this player into a switched power supply found on some amplifiers and AV receivers.

Connecting the DV-SP502/DV-SP502E—Continued

Connecting Your TV

- Connect the DV-SP502/DV-SP502E to the TV directly. If you connect the DV-SP502/DV-SP502E to a VCR, TV/VCR combination, or video selector, the playback picture may be distorted as DVD videos are copy protected.

Using S Video

If your TV (or other equipment) has an S Video input, you can use this instead of the standard (composite) output for a better quality picture.

- Use an S Video cable (supplied) to connect the S VIDEO OUTPUT to an S Video input on your TV (or monitor or AV receiver).

Line up the small triangle above the jack with the same mark on the plug before plugging in.

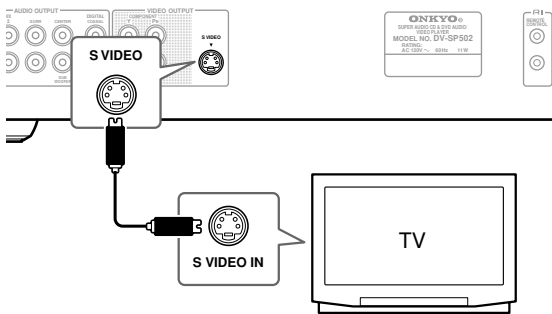

Using Component Video

You can use the component video output instead of the standard video out jack to connect this player to your TV (or other equipment).

This should give you the best quality picture from the three types of video output available.

- Use a component video cable (not supplied) to connect the COMPONENT VIDEO OUTPUT jacks to a component video input on your TV, monitor or AV receiver.

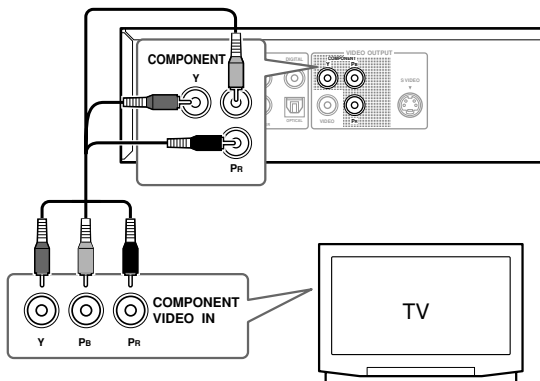

Note:

- Watching progressive scan video from the component video outputs

This player can output progressive scan video from the component video output. Compared to interlace video, progressive scan video effectively doubles the scanning rate of the picture, resulting in a very stable, flicker-free image. To set up the player for use with a progressive scan TV, see Video Output settings on page 46. When the player is set to output progressive scan video, the PROGRESSIVE indicator lights in the front panel display.

Important:

- If you connect a TV that is not compatible with a progressive scan signal and switch the player to progressive, you will not be able to see any picture at all. In this case, switch everything off and reconnect using the supplied video cable, then switch back to Interlace (see page 21).

Using SCART (European model only)

If your TV has a SCART-type AV input, you can use a SCART cable to connect this player to your TV. This type of connection carries both the sound and the picture, so there's no need to connect up the AUDIO OUTPUT L/R and VIDEO OUTPUT jacks.

- Use a SCART cable (supplied) to connect the AV CONNECTOR to an AV input on your TV.

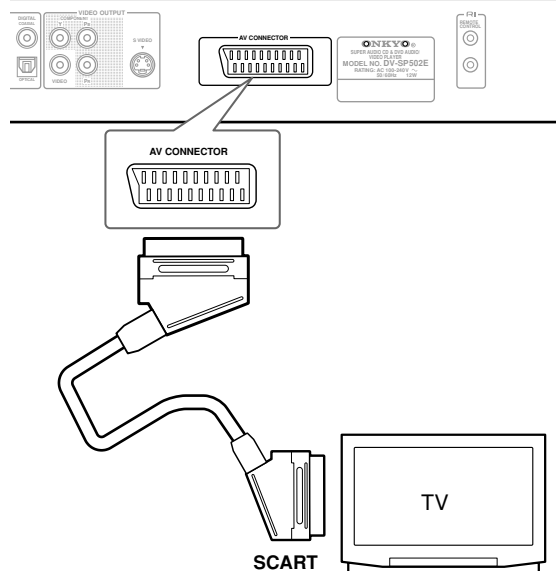

This connector can output composite video, S Video, or RGB video. The default setting is composite, which should work with all TVs. Consult the manual that came with your TV to see if you can use one of the higher quality settings. See page 46 for how to change the video output.

Connecting the DV-SP502/DV-SP502E—Continued

Switching the video output to interlace using the front panel controls

Switch the player to standby then, using the front panel controls, press STANDBY/ON while pressing **⏪** to switch the player back to Interlace.

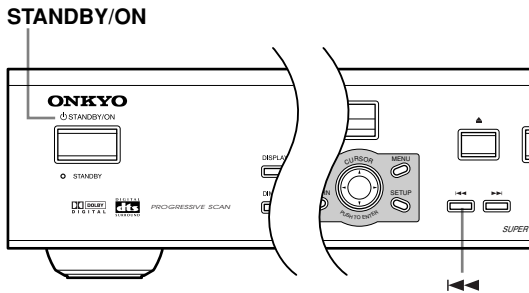

Compatibility of this player with progressive-scan and high-definition TVs

This player is compatible with progressive video Macro Vision System Copy Guard.

Consumers should note that not all high-definition television sets are fully compatible with this product and may cause artifacts to be displayed in the picture. In case of 525 progressive scan picture problems, it is recommended that the user switch the connection to the “standard definition” output (Interlace). If there are questions regarding our TV set compatibility with this model, please contact our customer service center.

Connecting the DV-SP502/DV-SP502E—Continued

Connecting to an AV Receiver

You can connect this player to your AV receiver using the multichannel analog outputs or one of the digital outputs. In addition to these connections, you should also connect the 2 channel analog outputs for compatibility with all discs. You'll probably also want to connect a video output to your AV receiver. You can use any of the video outputs available on this player.

Before connecting

- When you connect the DV-SP502/DV-SP502E to the amplifier, be sure to turn off the power and unplug both units from the mains before making any connections. Otherwise, the speakers may be damaged.
- Connect the plugs securely.

To enjoy surround sound you need to connect this player to an AV receiver using a digital output. This player has both coaxial and optical digital jacks; use whichever is convenient.

To record the audio from a CD-R disc etc. to a cassette or CDR recorder that's connected to the AV receiver, and when your AV receiver has Zone2, you must connect the DV-SP502/DV-SP502E's analog audio outputs to the AV receiver.

You'll probably also want to connect a video output to your AV receiver. You can use any of the video outputs available on this player (the illustration shows a standard (composite) connection).

Connecting the Digital Output

This player has both optical and coaxial-type digital audio outputs for connection to an AV receiver. Connect whichever is convenient.

In addition to a digital connection, we recommend also connecting using the stereo analog connection.

Depending on the capabilities of your AV receiver, you might have to set up this player to output only digital audio in a compatible format. See Digital Audio Out settings on page 46 and refer to the operating instructions that came with your AV receiver.

1. Connect one of DIGITAL AUDIO OUTPUT jacks on this player to a digital input on your AV receiver.

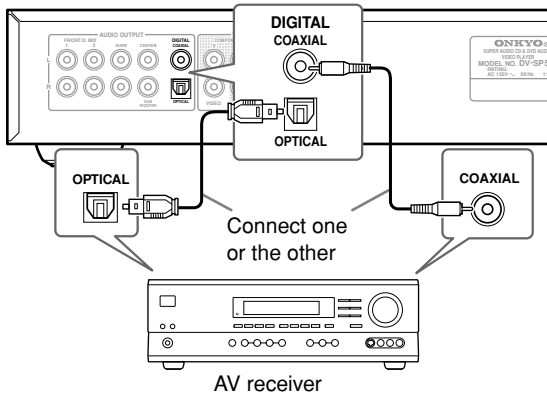

This enables you to listen to surround sound.

For an optical connection, use an optical cable (not supplied) to connect the "OPTICAL DIGITAL AUDIO OUTPUT" jack to an optical input on your AV receiver. For a coaxial connection, use a coaxial cable (similar to the supplied video cable) to connect the "COAXIAL DIGITAL AUDIO OUTPUT" jack to a coaxial input on your AV receiver.

Connecting the Analog Output

1. Connect the FRONT/D.MIX 1 or 2 AUDIO OUTPUT and VIDEO OUTPUT jacks on this player to a set of analog audio and video inputs on your AV receiver.

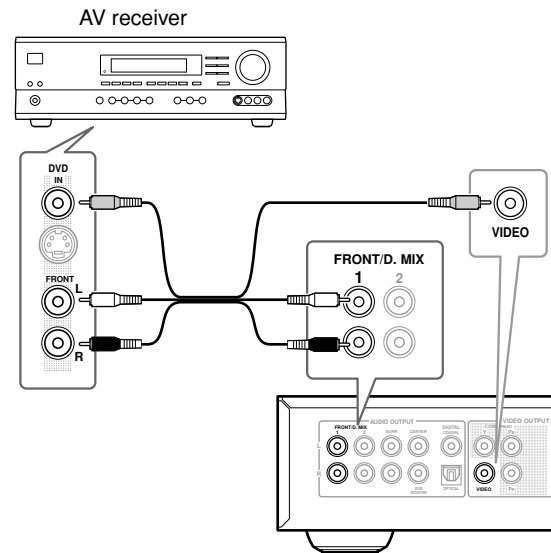

The diagram shows standard video connections, but you can alternatively use the S Video or component video connections if they're available.

2. Connect the AV receiver's video output to a video input on your TV.

You can use the SCART AV connector, or the S Video or component video jacks to connect to the AV receiver if you prefer.

Tip:

- You usually have to connect the same kind of video cable between your DV-SP502/DV-SP502E and AV receiver, and between your AV receiver and TV.

Connecting the DV-SP502/DV-SP502E—Continued

Connecting the Multichannel Analog Outputs

If your AV receiver has 5.1 channel analog inputs, we recommend connecting this player to it using the multichannel analog outputs. Doing this will ensure that you can enjoy all kinds of disc, including Dolby Digital and DTS DVD-Video discs, as well as high sampling rate and multichannel DVD-Audio and SACD discs.

1. Connect the **FRONT/D.MIX**, **SURR**, **CENTER**, **SUBWOOFER** outputs on this player to the **multi-channel audio inputs on your AV receiver**. It's convenient to use three stereo audio cables; one for the **FRONT/D.MIX 1 or 2**, one for the **SURR** and one for the **CENTER** and **SUBWOOFER** channels.

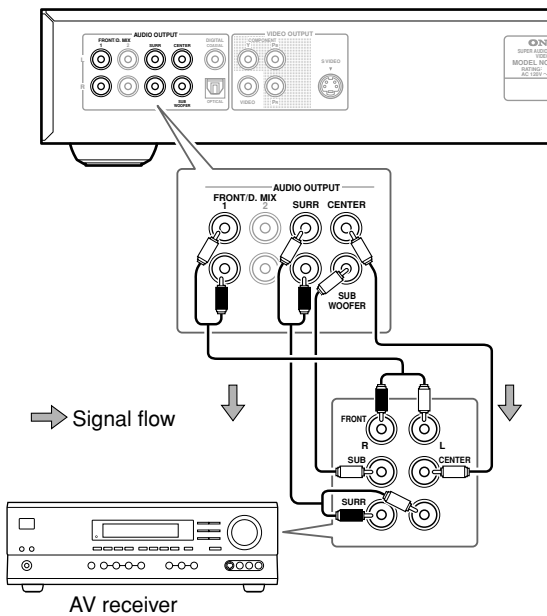

You can use the SCART AV connector, or the S video or component video jacks to connect to the AV receiver if you prefer.

Tip:

- After connecting up and switching on, you should change the Audio Output Mode setting in the Initial Setup menu from the default 2 Channel to 5.1 Channel. See also Audio Output Mode on page 48, 52.

Connecting RI-compatible Components

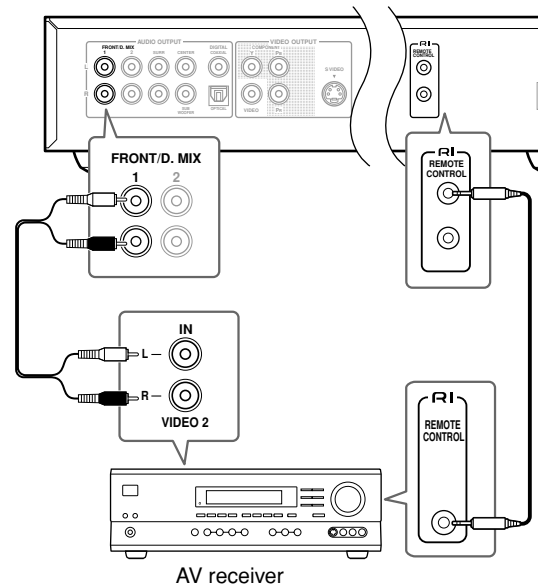

- The remote controller supplied with Onkyo AV receiver or amplifiers can be used to control the DV-SP502/DV-SP502E.
- The function of the upper and lower **RI** connectors are the same. Connect to either one.
- Connecting an **RI** cable only does not make the system operational. You must also connect the audio cables as well.
- For remote control operation, you must make an analog RCA connection between your DV-SP502/DV-SP502E and the other AV component, even if they are connected digitally.

Connecting the Power/Turning on the DV-SP502/DV-SP502E

Before connecting

- Make sure that all the connections on pages 18 – 23 are complete (the connection to a TV is required).

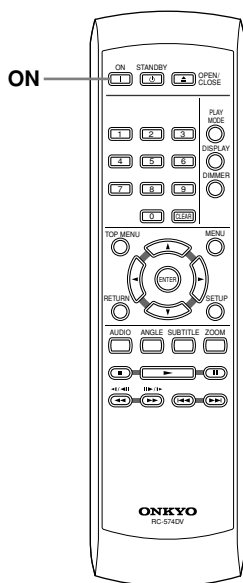
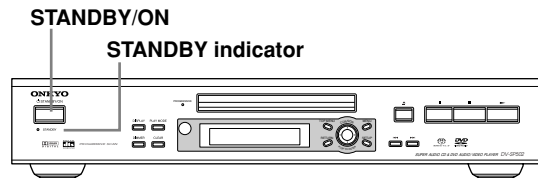

1

Plug the supplied power cord into the AC INLET and then into the power outlet on the wall.

- Do not use a power cord other than the one supplied with the DV-SP502/DV-SP502E. The power cord supplied is designed for use with the DV-SP502/DV-SP502E and should not be used with any other device.
- Never have the power cord disconnected from the DV-SP502/DV-SP502E while the other end is plugged into the wall outlet. Doing so may cause an electric shock. Always connect by plugging into the wall outlet last and disconnect by unplugging from the wall outlet first.

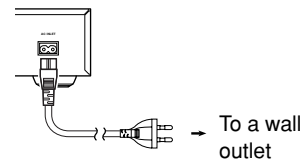

2

Press STANDBY/ON on the DV-SP502/DV-SP502E or ON on the remote controller.

The DV-SP502/DV-SP502E turns on and the STANDBY indicator turns off.

STANDBY/ON

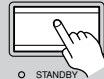

Remote controller

ON



- To put the DV-SP502/DV-SP502E in the standby mode, press STANDBY/ON on the DV-SP502/DV-SP502E, or STANDBY on the remote controller. Be sure to set the volume to minimum before putting the DV-SP502/DV-SP502E in the standby mode for the next use to avoid sudden loud sound reproduction.
- While the STANDBY indicator lights up, the DV-SP502/DV-SP502E can receive signals from the remote controller.
- Setting the STANDBY/ON button to standby does not shut off the power completely.

Note:

- This player features a screen saver and an auto power off function. If the player is stopped and no button is pressed for five minutes, the screen saver starts. If the disc tray is closed but no disc is playing and no control is pressed for 30 minutes, the player automatically goes into standby.

Getting Started

Using the on-screen displays

For ease of use, this player makes extensive use of graphical on-screen displays (OSDs). All the screens are navigated in basically the same way, using the cursor buttons (◀/▶/▲/▼) to change the highlighted item and pressing ENTER to select it.

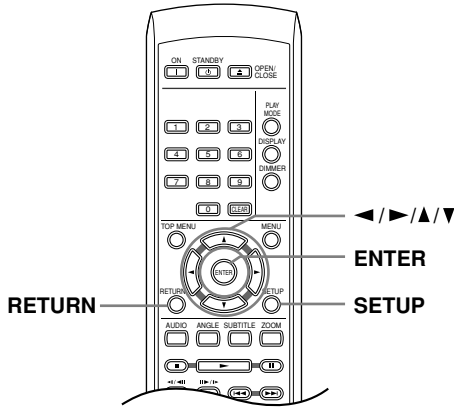

Setting up the player for your TV

If you have a widescreen (16:9) TV, you should setup the player so that the picture will be presented correctly. If you have a conventional (4:3) TV, you can leave the player on the default setting and move on to the next section.

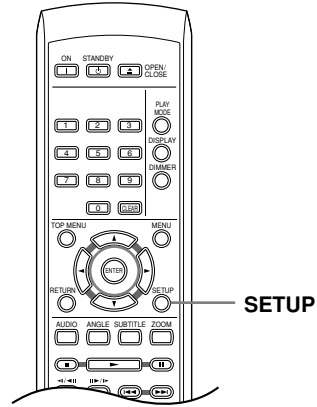

Note:

- From here on in this manual, the word “select” generally means use the cursor buttons to highlight an item on-screen, then press ENTER.

Button	What it does
	Display/exit the on-screen display.
	Changes the highlighted menu item.
	Selects the highlighted menu item (both ENTER buttons on the remote work in exactly the same way).
	Returns to the main menu without saving changes.

- 1 Press SETUP and select “Initial Settings”.**
- 2 Select “TV Screen” from the “Video Output” settings.**
- 3 If you have a widescreen (16:9) TV, select “16:9 (Wide)”.**

If you have a conventional (4:3) TV, you can change the setting from 4:3 (Letter Box) to 4:3 (Pan & Scan) if you prefer. See “Video Output settings” on page 46 for more details.
- 4 Press SETUP to exit the menu screen.**

Getting Started—Continued

Setting the language of this player's on-screen displays

This sets the language of this system's on-screen displays.

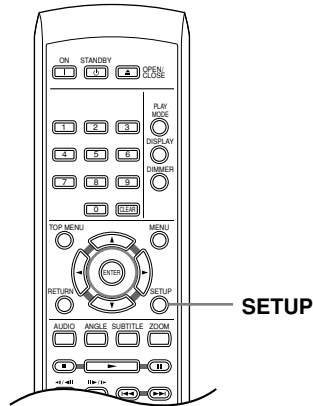

1



Press **SETUP** and select "Initial Settings".

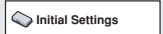

2

Select "OSD Language" from the "Display" settings.

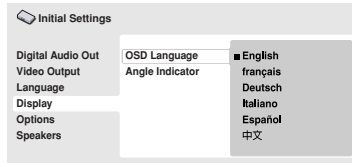

The available languages vary between models.

- North American and European models: English, French, Spanish, German, Italian, Other Language.
- Australian, Asian and South American models: English, French, Spanish, Chinese, Other Language.
- Note that the language you choose here may not be available on all discs.
- If you want to select a language other than those listed, select "Other Language." See "Selecting languages using the language code list" on page 56 for detailed information.

3

Select a language.

The on-screen language will change according to your selection.

4



Press **SETUP** to exit the menu screen.

Playing discs

The basic playback controls for playing DVD, CD, SACD, Video CD and MP3/WMA discs are covered here. Further functions are detailed in the next chapter. For details on playing JPEG picture discs, see "Viewing a JPEG slideshow" on page 31.

Important:

- Throughout this manual, the term "DVD" means DVD-Video, DVD-Audio and DVD-R/ RW. If a function is specific to a particular kind of DVD disc, it is specified.

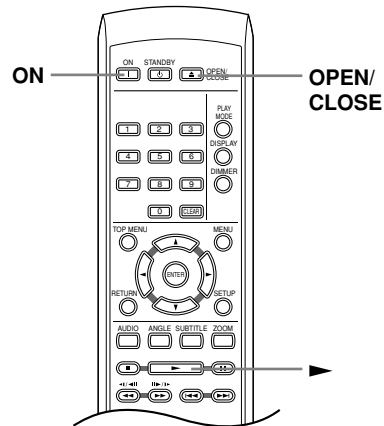
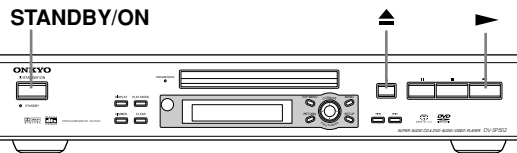

1

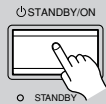

If the player isn't already on, press **STANDBY/ON** to switch it on.

If you're playing a DVD or Video CD, also turn on your TV and make sure that it is set to the correct video input.

2



Press **▲ OPEN/CLOSE** to open the disc tray.



Getting Started—Continued

3

Load a disc.

Load a disc with the label side facing up, using the disc tray guide to align the disc (if you're loading a double-sided DVD disc, load it with the side you want to play face down).

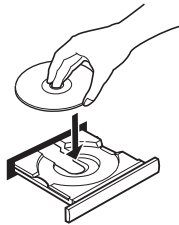

4

Press ► (play) to start playback.

If you're playing a DVD or Video CD, an on-screen menu may appear. See "DVD disc menus" on page 28 and "Video CD PBC menus" on page 29 for more on how to navigate these.



- If you're playing an MP3/WMA disc, it may take a few seconds before playback starts.

Note:

- You may find with some DVD discs that some playback controls don't work in certain parts of the disc. This is not a malfunction.

Basic playback controls

The table below shows the basic controls on the remote for playing discs. The following chapter covers other playback features in more detail.

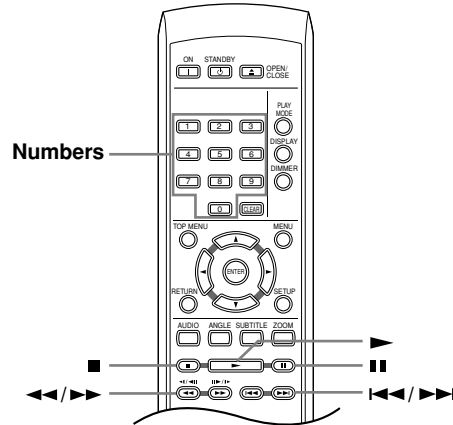

Button	What it does
►	Starts playback. If the display shows RESUME or LAST MEM playback starts from the resume or last memory point (see also "Resume and Last Memory" on page 28.)
	Pauses a disc that's playing, or restarts a paused disc.
■	Stops playback. See also "Resume and Last Memory" on page 28.
◀◀ (remote only)	Press to start fast reverse scanning. Press ► (play) to resume normal playback.
▶▶ (remote only)	Press to start fast forward scanning. Press ► (play) to resume normal playback.
◀◀	Skips to the start of the current track or chapter, then to previous tracks/chapters.
▶▶	Skips to the next track or chapter.
Numbers (remote only)	Use to enter a title/chapter/track number. Press ENTER to select. <ul style="list-style-type: none"> • If the disc is stopped, playback starts from the selected title (for DVD), group (for DVD-Audio) or track (for CD/SACD/Video CD). • If the disc is playing, playback jumps to the start of the selected title (VR mode DVD-RW), chapter (DVD-Video) or track (DVD-Audio^{*1}/SACD/CD/Video CD) *1 within the current group

Getting Started—Continued

Resume and Last Memory

With the exception of DVD-Audio and SACD discs, when you stop playback of a disc, RESUME is shown in the display indicating that you can resume playback again from that point.

If the disc tray is not opened, the next time you start playback the display shows RESUME and playback resumes from the resume point. (If you want to clear the resume point, press ■ (stop) while RESUME is displayed.)

If you take a VCD out of the player after stopping playback, the last play position is stored in memory. If the next disc you load is the same one, the display shows LAST MEM and playback will resume. For DVD-Video discs (except VR mode DVD-RW), the player stores the play position of the last five discs. When one of these discs is next loaded, you can resume playback.

Notes:

- The Last Memory function doesn't work with VR format DVD-RW, DVD-Audio or SACD discs.
- If you don't need the Last Memory function when you stop a disc, you can press ▲ OPEN/CLOSE to stop playback and open the disc tray.

DVD disc menus

Many DVD-Video and DVD-Audio discs feature menus from which you can select what you want to watch.

They may also give access to additional features, such as subtitle and audio language selection, or special features such as slideshows. See the disc packaging for details. Sometimes DVD-Video menus are displayed automatically when you start playback; others only appear when you press MENU or TOP MENU.

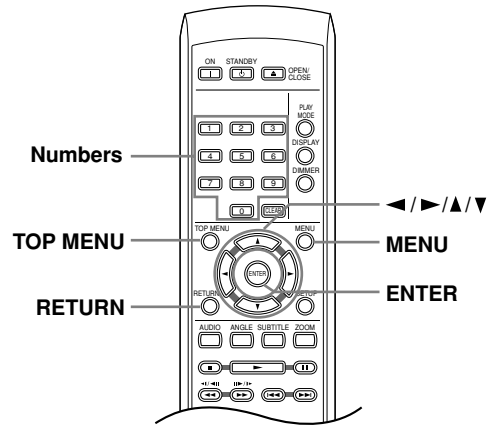

Important:

- Some DVD-Audio discs feature a “bonus group”. To play this group you first have to input a password, which you can find on the disc’s packaging. Use the number buttons to input the password.

Button	What it does
TOP MENU	Displays the “top menu” of a DVD disc—this varies with the disc.
MENU	Displays a DVD disc menu—this varies with the disc and may be the same as the “top menu”.
◀/▶/▲/▼	Moves the cursor around the screen.
ENTER	Selects the current menu option.
RETURN	Returns to the previously displayed menu screen. On some DVD-Audio discs featuring browsable pictures, press to display the browser screen.
Numbers (remote only)	Highlights a numbered menu option (some discs only). Press ENTER to select.

Getting Started—Continued

Video CD PBC menus

Some Video CD have menus from which you can choose what you want to watch. These are called PBC (Playback control) menus.

You can play a PBC Video CD without having to navigate the PBC menu by starting playback using a number button to select a track, rather than the ► (play) button.

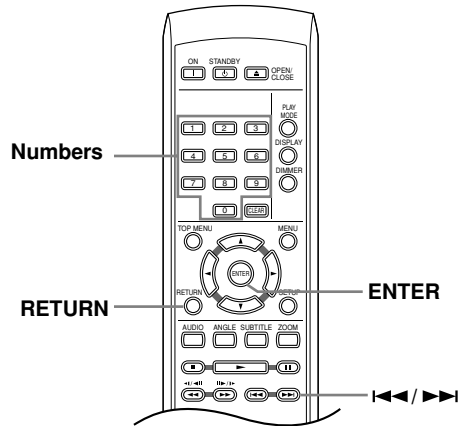

Button	What it does
RETURN	Displays the PBC menu.
Numbers (remote only)	Use to enter a numbered menu option. Press ENTER to select.
◀◀	Displays the previous menu page (if there is one).
▶▶	Displays the next menu page (if there is one).

Playing discs

Notes:

- Many of the functions covered in this chapter apply to DVD and SACD discs, Video CDs, CDs and WMA/MP3 JPEG discs, although the exact operation of some varies slightly with the kind of disc loaded.
- Some DVDs restrict the use of some functions (random or repeat, for example) in some or all parts of the disc. This is not a malfunction.
- When playing Video CD, some of the functions are not available during PBC playback. If you want to use them, start the disc playing using a number button to select a track.

Scanning discs

You can fast-scan discs forward or backward at four different speeds.

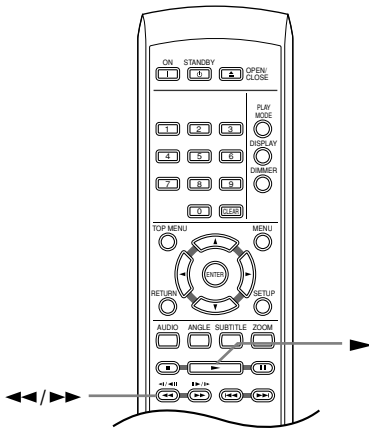

1	<p>During playback, press ◀◀ or ▶▶ to start scanning.</p> <ul style="list-style-type: none"> • There is no sound while scanning DVDs (including DVD-Audio) and Video CD/ Super VCDs.
2	<p>Press repeatedly to increase the scanning speed.</p> <ul style="list-style-type: none"> • The scanning speed is shown on-screen.
3	<p>To resume normal playback, press ▶ (play).</p> <ul style="list-style-type: none"> • When scanning a Video CD playing in PBC mode or a WMA/MP3 track, playback automatically resumes at the end or beginning of the track. • Depending on the disc, normal playback may automatically resume when a new chapter is reached on a DVD disc.

Playing in slow motion

Playing in slow motion You can play DVD-Videos and DVD-R/RW at four different slow motion speeds, forwards and backwards. Video CD/Super VCDs can be played at four different forward slow motion speeds.

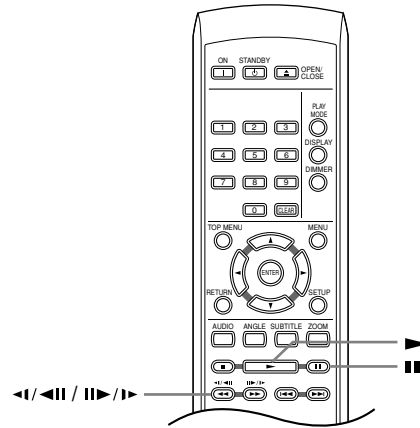

1	<p>During playback, press (pause).</p>
2	<p>Press and hold ◀◀/◀ or /▶▶ until slow motion playback starts.</p> <ul style="list-style-type: none"> • The slow motion speed is shown on-screen. • There is no sound during slow motion playback.
3	<p>Press repeatedly to change the slow motion speed.</p>
4	<p>To resume normal playback, press ▶ (play).</p> <ul style="list-style-type: none"> • Depending on the disc, normal playback may automatically resume when a new chapter is reached.

Note:



- Backward slow-motion playback does not work with Video CD.

Playing discs—Continued

Frame advance/frame reverse

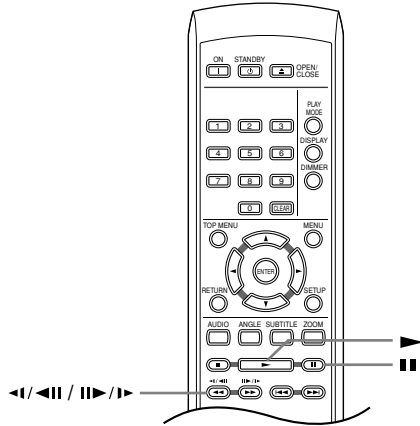
You can advance or back up DVD-Video and DVD-R/RW discs frame-by-frame. With Video CD you can only use frame advance.

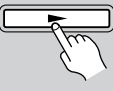

- 1** During playback, press **||** (pause).
 
- 2** Press **<|/|<** or **||>|/|>** to reverse or advance a frame at a time.
 
- 3** To resume normal playback, press **▶** (play).
 - Depending on the disc, normal playback may automatically resume when a new chapter is reached.

Note:

- Backward frame-by-frame playback does not work with Video CD.

Viewing a JPEG slideshow

After loading a CD/CD-R/RW containing JPEG picture files, press **▶** (play) to start a slideshow from the first folder/picture on the disc. The player displays the pictures in each folder in alphabetical order.

Pictures are automatically adjusted so that they fill as much of the screen as possible (if the aspect ratio of the picture is different to your TV screen you may notice black bars at the sides, or at the top and bottom of the screen).

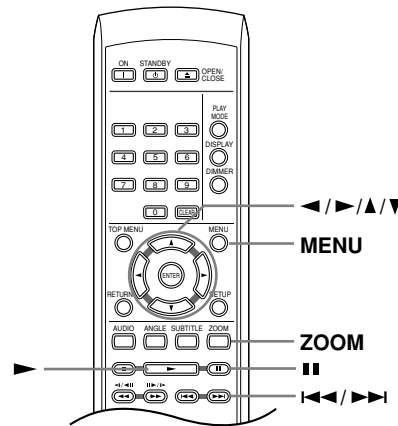

While the slideshow is running:

Button	What it does
 	Pauses the slideshow; press again to restart.
<<<	Displays the previous picture.
>>>	Displays the next picture.
</>	Pauses the slideshow and rotates the displayed picture 90° (counter)clockwise. (Press ▶ (play) to restart slideshow).
▲/▼	Pauses the slideshow and flips the displayed picture horizontally or vertically. (Press ▶ (play) to restart slideshow).
ZOOM	Pauses the slideshow and zooms the picture. Press again to toggle between 1x, 2x and 4x zoom. (Press ▶ (play) to restart slideshow).
MENU	Displays the Disc Navigator screen (see below).

Notes:

- The time it takes for the player to load a file increases with large file sizes.
- Discs can contain up to 299 folders and up to 648 folders and files combined.

Playing discs—Continued

Browsing video content with the Disc Navigator

Use the Disc Navigator to browse through the contents of a DVD-Video, DVD-RW or Video CD disc to find the part you want to play.

Important:

- You can't use the Disc Navigator with Video CD in PBC mode.

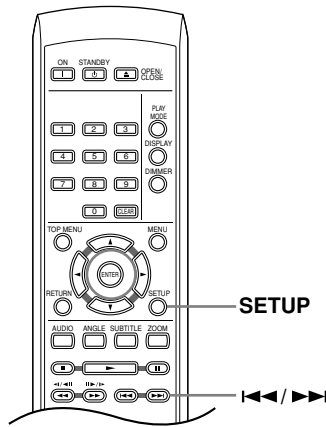

1



During playback, press **SETUP** and select "Disc Navigator" from the on-screen menu.

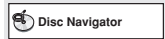

2

Select a view option.

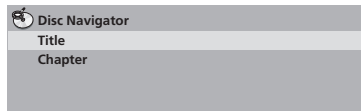

The options available depend on the kind of disc loaded and whether the disc is playing or not, but include:

- Title** – Titles from a DVD-Video disc.
- Chapter** – Chapters from the current title of a DVD-Video disc.
- Track** – Tracks from a Video CD disc.
- Time** – Thumbnails from a Video CD disc at 10 minute intervals.
- Original: Title** – Original titles from a VR mode DVD-RW disc.

- Playlist: Title** – Playlist titles from a VR mode DVD-RW disc.
- Original: Time** – Thumbnails from the Original content at 10 minute intervals.
- Playlist: Time** – Thumbnails from the Playlist at 10 minute intervals.

The screen shows up to six moving thumbnail images displayed one after another. To display the previous/next six thumbnails, press **◀/▶** (you don't have to wait for all the thumbnails to finish playing to display the previous/next page).

3



Select the thumbnail image for what you want to play.

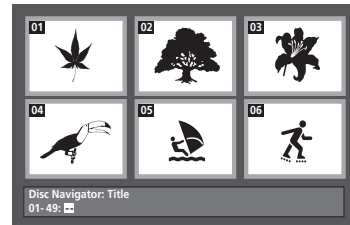

You can use either the cursor buttons (**◀/▶/▲/▼**) and **ENTER** to select a thumbnail, or the number buttons.

To select using the number buttons, enter a two-digit number then press **ENTER**.

Tip:

- Another way to find a particular place on a disc is to use one of the search modes. See "Searching a disc" on page 37.

Playing discs—Continued

Browsing WMA, MP3 and JPEG files with the Disc Navigator

Use the Disc Navigator to find a particular file or folder by filename.

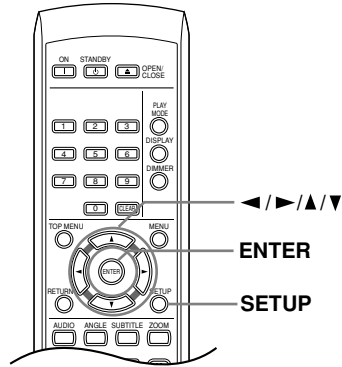

3

To play the highlighted track or display the highlighted JPEG file, press **ENTER**.



- When a WMA/MP3 file is selected, playback begins, starting with the selected track, and continues until the end of the folder.
- When a JPEG file is selected, a slide-show begins, starting with that file, and continues to the end of the folder.

Tip:

- To play the contents of the whole disc rather than just the current folder, exit the Disc Navigator and start playback using the ► (play) button.

1

SETUP



Press **SETUP** and select “Disc Navigator” from the on-screen menu.

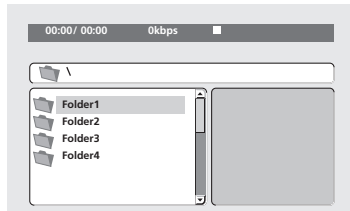

2



Use the cursor buttons (▲/▼/◀/▶) and **ENTER** to navigate.

Use the cursor up/down buttons (▲/▼) to move up and down the folder/file list.

Use the cursor left button (◀) to return to the parent folder.

Use **ENTER** or cursor right (▶) to open a highlighted folder.

- You can also return to the parent folder by going to the top of the list to the “..” folder, then pressing **ENTER**.
- When a JPEG file is highlighted, a thumbnail image is displayed on the right.

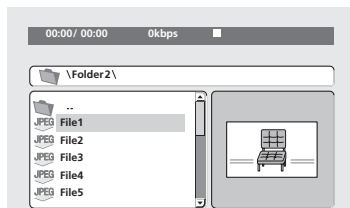

Playing discs—Continued

Looping a section of a disc

The A-B Repeat function allows you to specify two points (A and B) within a track (CD, Video CD) or title (DVD-Video and DVD-RW) that form a loop which is played over and over.

- You can't use A-B Repeat with DVD-Audio, SACD, and Video CD in PBC mode, or WMA /MP3 files.

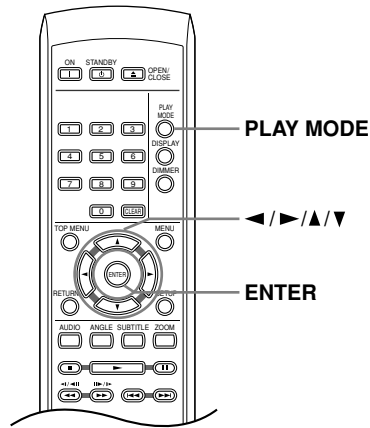

Using repeat play

There are various repeat play options, depending on the kind of disc loaded. It's also possible to use repeat play together with program play to repeat the tracks/chapters in the program list (see "Creating a program list" on page 36).

Important:

- You can't use Repeat play with Video CD in PBC mode, or with WMA/MP3 discs.
- You can't use repeat and random play at the same time.

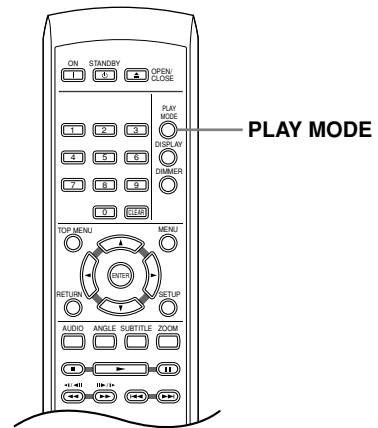

- 1** During playback, press **PLAY MODE** and select "A-B Repeat" from the list of functions on the left.

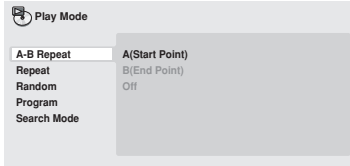

- 2** Press **ENTER** on "A(Start Point)" to set the loop start point.

- 3** Press **ENTER** on "B(End Point)" to set the loop end point.
After pressing ENTER, playback jumps back to the start point and plays the loop.

- 4** To resume normal playback, select "Off" from the menu.

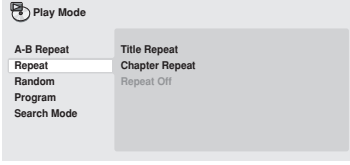
- 1** During playback, press **PLAY MODE** and select "Repeat" from the list of functions on the left.

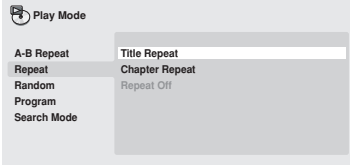

- 2** Select a repeat play option.
If program play is active, select Program Repeat to repeat the program list, or Repeat Off to cancel.
The repeat options available depend on the kind of disc loaded. For example, for DVD-Video and DVD-RW discs, you can select Title Repeat or Chapter Repeat (or Repeat Off).

 - For DVD-Audio discs, select Group Repeat or Track Repeat (or Repeat Off).
 - For SACDs, CDs and Video CD, select Disc Repeat or Track Repeat (or Repeat Off).

Playing discs—Continued

Using random play

Use the random play function to play titles or chapters (DVD-Video), Groups (DVD-Audio), or tracks (DVD-Audio, SACD, CD, Video CD) at random. (Note that the same track/title/chapter may play more than once.)

You can set the random play option when a disc is playing or stopped.

Important:

- Random play remains in effect until you select Random Off from the random play menu options.
- You can't use random play with VR format DVD-RW discs, Video CD playing in PBC mode, WMA/MP3 discs, or while a DVD disc menu is being displayed.
- You can't use random play together with program or repeat play.

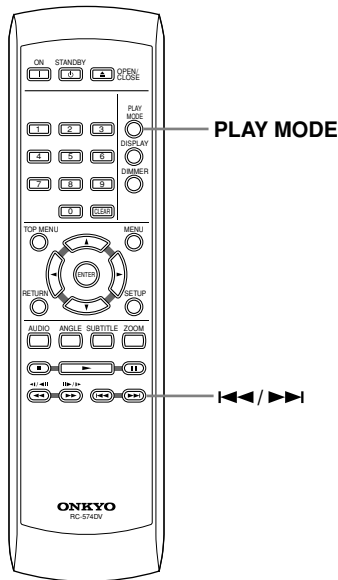

1

PLAY MODE



Press **PLAY MODE** and select **“Random”** from the list of functions on the left.



2

Select a random play option.

The random play options available depend on the kind of disc loaded. For example, for DVD-Video discs, you can select Random Title or Random Chapter, (or Random Off).



- For DVD-Audio discs, select Random Group or Random Track, (or Random Off).
- For CDs, SACDs and Video CD, select On or Off to switch random play on or off.

Tip:

- Use the following controls during random play:

Button	What it does
	Selects a new track/title/chapter at random.
	Returns to the beginning of the current track/title/chapter; further presses select another random track/title/chapter.

Playing discs—Continued

Creating a program list

This feature lets you program the play order of titles/chapters/tracks on a disc.

Important:

- You can't use Program play with VR format DVD-RW discs, Video CD playing in PBC mode, WMA/MP3 discs, or while a DVD disc menu is being displayed.

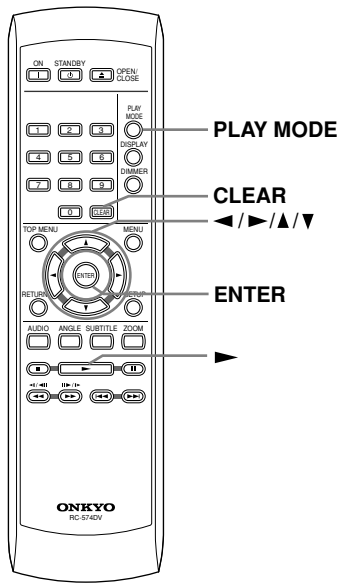

1 Press **PLAY MODE** and select **“Program”** from the list of functions on the left.

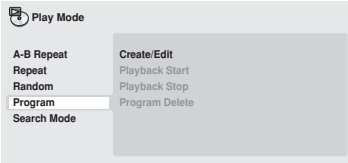

2 Select **“Create/Edit”** from the list of program options.

3 Use the cursor buttons and **ENTER** to select a title, chapter or track for the current step in the program list.

For a DVD-Video disc, you can add a title or a chapter to the program list.

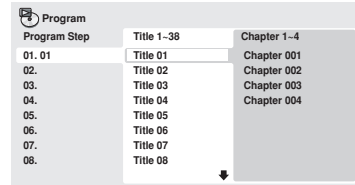

- For a DVD-Audio disc, you can add a whole group, or a track within a group to the program list.
- For a CD, SACD or Video CD, select a track to add to the program list.

After pressing **ENTER** to select the title/chapter/track, the step number automatically moves down one.

4 Repeat step 3 to build up a program list.

A program list can contain up to 24 titles/chapters/tracks.

- You can insert steps into the middle of a program list by just highlighting the position where you want the new step to appear and entering a title/chapter/track number.
- To delete a step, highlight it and press **CLEAR**.

5 To play the program list, press **▶ (play)**.

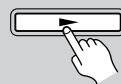

Program play remains active until you turn off program play (see below), erase the program list (see below), eject the disc or switch off the player.

Tip:

Use the following controls during program play:

Button	What it does
PLAY MODE	Save the program list and exit the program edit screen without starting playback (SETUP does the same).
▶▶	Skip to the next step in the program list.

Playing discs—Continued

Other functions available from the program menu

There are a number of other options in the program menu in addition to Create/Edit.

- **Playback Start** – Starts playback of a saved program list
- **Playback Stop** – Turns off program play, but does not erase the program list
- **Program Delete** – Erases the program list and turns off program play

Searching a disc

You can search DVD-Video discs by title or chapter number, or by time; DVD-Audio discs can be searched by group or track number; SACDs by track number, CDs and Video CD by track number or time.

Important:

- Search functions are not available with Video CD in PBC mode, or with WMA/MP3 discs.

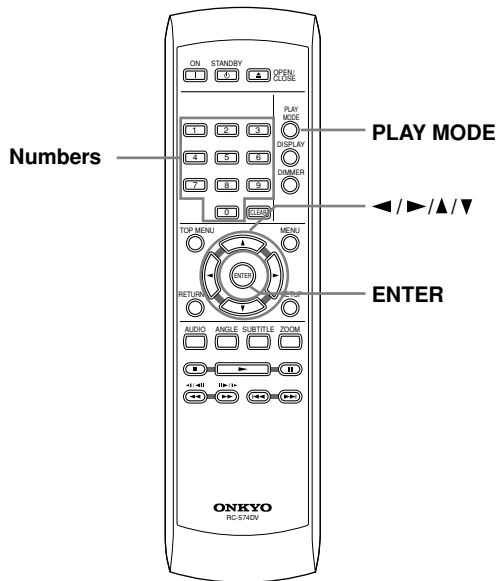

3



Use the number buttons to enter a title, chapter or track number, or a time.

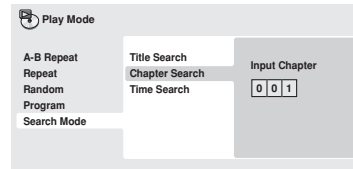

- For a time search, enter the number of minutes and seconds into the currently playing title (DVD) or track (CD/Video CD) you want playback to resume from. For example, press 4, 5, 0, 0 to have playback start from 45 minutes into the disc. For 1 hour, 20 minutes and 30 seconds, press 8, 0, 3, 0.
- Some DVD-Audio discs feature pages of browsable pictures. Enter the page number you want.

4



Press ENTER to start playback.

1

PLAY MODE



Press PLAY MODE and select "Search Mode" from the list of functions on the left.

The search options available depend on the kind of disc loaded.

2

Select a search mode.

- The disc must be playing in order to use time search.

Playing discs—Continued

Switching subtitles

Some DVD-Video discs have subtitles in one or more languages; the disc box will usually tell you which subtitle languages are available. You can switch subtitle language during playback.

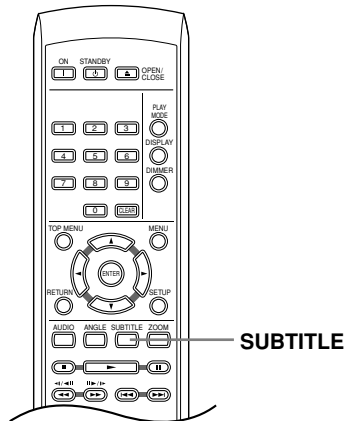

1

SUBTITLE



Press SUBTITLE repeatedly to select a subtitle option.

Current / Total
Subtitle 1 / 2 English

Notes:

- Some discs only allow you to change subtitle language from the disc menu. Press TOP MENU or MENU to access.
- To set subtitle preferences, see “Language settings” on page 47.

Switching audio language/channel

When playing a DVD-Video disc recorded with dialog in two or more languages, you can switch audio language during playback.

When playing a VR format DVD-RW disc recorded with dual-mono audio, you can switch between the main, sub, and mixed channels during playback.

When playing a DVD-Audio disc, you may be able to switch channels—see the disc box for details. (When you change the audio channel, playback restarts from the beginning of the current track.)

When playing a Video CD, you can switch between stereo, just the left channel or just the right channel.

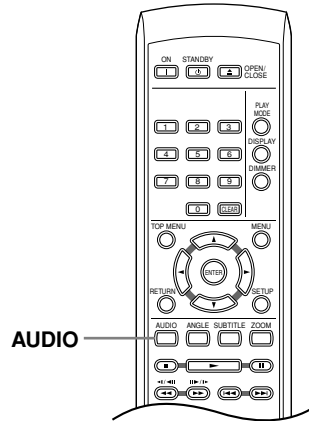

1

AUDIO



Press AUDIO repeatedly to select an audio language/channel option.

The language/channel information is shown on-screen.

Notes:

- Some DVD discs only allow you to change audio language from the disc menu. Press TOP MENU or MENU to access.
- To set DVD audio language preferences, see “Language settings” on page 47.

Playing discs—Continued

Zooming the screen

Using the zoom feature you can magnify a part of the screen by a factor of 2 or 4, while watching a DVD or Video CD or playing a JPEG disc.

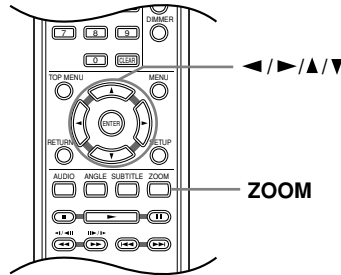

1



During playback, use the ZOOM button to select the zoom factor (Normal, 2x or 4x).

- Since DVD, Video CD and JPEG pictures have a fixed resolution, picture quality will deteriorate, especially at 4x zoom. This is not a malfunction.

2

Use the cursor buttons to change the zoomed area.

- You can change the zoom factor and the zoomed area freely during playback.
- If the navigation square at the top of the screen disappears, press ZOOM again to display it.

Note:

- If you are displaying subtitles, these will disappear when the screen is zoomed. They will reappear when you return the screen to normal.

Switching camera angles

Some DVD discs feature scenes shot from two or more angles—check the disc box for details.

When a multi-angle scene is playing, a  icon appears on screen to let you know that other angles are available (this can be switched off if you prefer—see “Display settings” on page 47).

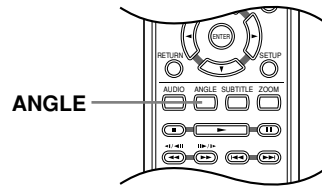

1



During playback (or when paused), press ANGLE to switch angle.

Displaying disc information

Various track, chapter and title information, such as the elapsed and remaining playing time can be displayed on-screen while a disc is playing.

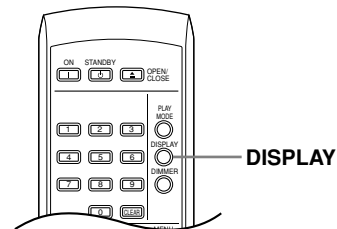

1



To show/switch/hide the information displayed, press DISPLAY repeatedly.

- When a disc is playing, the information appears at the top of the screen.

DivX[®] video playback on the DV-SP502/DV-SP502E (not North American model)

About DivX

DivX is a compressed digital video format created by the DivX[®] video codec from DivXNetworks, Inc. This player can play DivX video files burned on CD-R/RW/ROM discs. Keeping the same terminology as DVD-Video, individual DivX video files are called "Titles." When naming files/titles on a CD-R/RW disc prior to burning, keep in mind that by default they will be played in alphabetical order.

DivX video compatibility

- Official DivX[®] Certified product.
- Plays DivX[®] 5, DivX[®] 4, DivX[®] 3 and DivX[®] VOD video content (in compliance with DivX[®] Certified technical requirements).
- File extensions: .avi and .divx (these must be used for the player to recognize DivX video files). Note that all files with the .avi extension are recognized as MPEG4, but not all of these are necessarily DivX video files and therefore may not be playable on this player.
- Media: ISO 9660* formatted CD-R/RW/ROM
* ISO 9660 Level 1 or 2 compliant. CD physical format: Mode1, Mode2 XA Form1. Romeo and Joliet file systems are both compatible with this player.
- Multi-session playback: No
- Unfinalized disc playback: No
- File structure: Up to 299 folders; up to 648 folders and files combined per folder.

DivX, DivX Certified, and associated logos are trademarks of DivXNetworks, Inc. and are used under license.













Playing DivX video

If a disc contains only DivX video files, you can start playback right away. The table below shows all the basic playback controls.

If a disc contains a mixture of DivX video and other media file types (MP3, for example), first select whether to play the DivX video files (DivX) or the other media file types (MP3/WMA/JPEG) from the on-screen display.

Note:



- The player may take some time to find a title on a disc when you start playback, etc. This is normal.

Button	What it does
	Starts or resumes playback. Titles are played in alphabetical order.
	Pauses a disc that's playing, or restarts a paused disc.
	Stops playback. RESUME shows in the front panel display indicating that you can resume playback (press  again to clear the resume point). Note that the resume point is lost if you switch the player off.
	Press to start fast reverse scanning. Press  (play) to resume normal playback.
	Press to start fast forward scanning. Press  (play) to resume normal playback.
	Skips to the start of the current title, then to previous titles.
	Skips to the next title.
	Press  , then press to advance one frame. Press and hold  to start slow motion playback (press repeatedly to change the slow motion play speed).
AUDIO	Press to display the playback audio type; press repeatedly to change the playback audio type.
SUBTITLE	Press to display subtitle information; press repeatedly to change subtitles.
ZOOM	Press to zoom the screen. Press repeatedly to change the zoom factor (2x, 4x, Normal).
DISPLAY	Press repeatedly to show various disc related information, such as elapsed, remaining and total playing time, and the title name.

DivX® video playback on the DV-SP502/DV-SP502E (not North American model)—Continued

Browsing DivX video titles using the Disc Navigator

Use the Disc Navigator to browse the contents of a disc. Note that if there are other types of files on the same disc, these will not be displayed in the Disc Navigator.

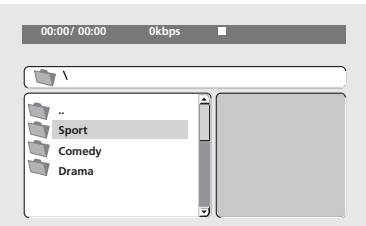
1	 <p>Press SETUP and select “Disc Navigator” from the on-screen menu.</p>
2	 <p>Use the cursor buttons (▲/▼/◀/▶) and ENTER to navigate.</p>  <p>Use the cursor up/down buttons (▲/▼) to move up and down the folder/title list. Use the cursor left button (◀) to return to the parent folder. Use ENTER or cursor right (▶) to open a highlighted folder.</p> <ul style="list-style-type: none"> You can also return to the parent folder by going to the top of the list to the “..” folder, then pressing ENTER.
3	<p>To play the highlighted title, press ENTER.</p> <ul style="list-style-type: none"> Playback begins, starting with the selected title, and continues until the end of the folder. <p>Note:</p> <ul style="list-style-type: none"> For DivX title playback, Onkyo tested and verified the combination of video and audio data as listed on page 60. When you create a new DivX file, refer to this list. Onkyo does not guarantee the quality or operation of DivX files that contain any combinations other than those listed in this manual.

Tip:

- To play the contents of the whole disc rather than just the current folder, exit the Disc Navigator and start playback using the ▶ (play) button.

Using repeat play

You can use the repeat play feature to repeat individual titles on a disc.

1	During playback, press PLAY MODE and select “Repeat” from the list of functions on the left.
2	<p>Select a repeat play option.</p> <ul style="list-style-type: none"> Title Repeat – Repeat the currently playing title. Repeat Off – Switch off repeat play.

Using time search

Use the time search to jump to a specified point in the currently playing DivX title.

1	During playback, press PLAY MODE and select “Search Mode” from the list of functions on the left.
2	Select “Time Search”.
3	<p>Use the number buttons to enter a time.</p> <p>Enter the number of minutes and seconds into the currently playing title you want playback to resume from. For example, press 4, 5, 0, 0 to have playback start from 45 minutes into the title.</p>
4	Press ENTER to start playback.

DivX® video playback on the DV-SP502/DV-SP502E (not North American model)—Continued

About DivX® VOD content

In order to play DivX VOD (video on demand) content on this player, you first need to register the player with your DivX VOD content provider. You do this by generating a DivX VOD registration code, which you submit to your provider.

Important:



- DivX VOD content is protected by a DRM (Digital Rights Management) system. This restricts playback of content to specific, registered devices.
- If you load a disc that contains DivX VOD content not authorized for your player, the message Authorization Error is displayed and the content will not play.
- Resetting the player (as described in Resetting the player in the main Operating Instructions) will not cause you to lose your registration code.

Playing DivX® VOD content

Some DivX VOD content may only be playable a fixed number of times. When you load a disc containing this type of DivX VOD content, the remaining number of plays is shown on-screen and you then have the option of playing the disc (thereby using up one of the remaining plays), or stopping. If you load a disc that contains expired DivX VOD content (for example, content that has zero remaining plays), the message Rental Expired is displayed.

If your DivX VOD content allows an unlimited number of plays, then you may load the disc into your player and play the content as often as you like, and no message will be displayed.

Displaying your DivX VOD registration code

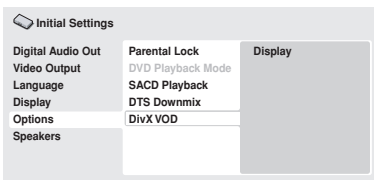
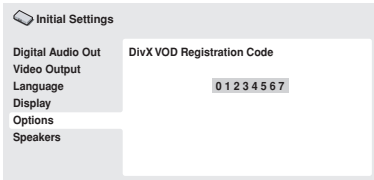
<p>1</p> 	<p>Press SETUP and select "Initial Settings".</p>
<p>2</p> 	<p>Select "Options", then "DivX VOD".</p> 
<p>3</p>	<p>Select "Display". Your 8-digit registration code is displayed.</p>  <p>Make a note of the code as you will need it when you register with a DivX VOD provider.</p>

Audio Settings and Video Adjust menus

Audio Settings menu

The Audio Settings menu offers features for adjusting the way discs sound.

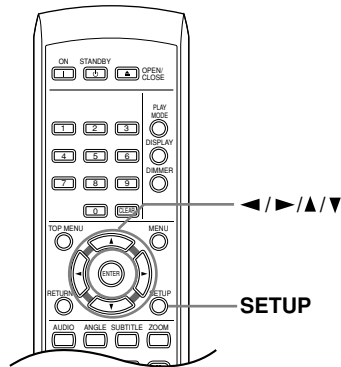

Audio DRC

- Settings: High, Medium, Low, Off (default)

When watching Dolby Digital DVDs at low volume, it's easy to lose the quieter sounds completely—including some of the dialog. Switching Audio DRC (Dynamic Range Control) to on can help by bringing up the quieter sounds, while controlling loud peaks.

How much of a difference you hear depends on the material you're listening to. If the material doesn't have wide variations in volume, you may not notice much change.

Notes:

- Audio DRC is only effective with Dolby Digital audio sources.
- Audio DRC is only effective through the digital output when Digital Out is set to On, and Dolby Digital Out is set to Dolby Digital > PCM (see "Digital Audio Out settings" on page 46).
- The effect of Audio DRC depends on your speakers and AV receiver settings.

1

Press **SETUP** and select "Audio Settings" from the on-screen display.

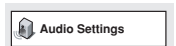
2

Select and change settings using the **▲/▼/◀/▶** (cursor) buttons, and **ENTER**.



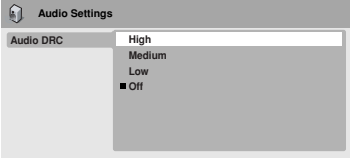



Audio Settings and Video Adjust menus—Continued

Video Adjust menu

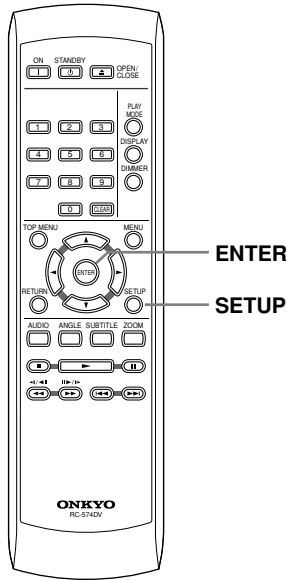
From the Video Adjust screen you can adjust various settings that affect how the picture is presented.



- **Hue** – Adjusts the red/green balance (Green 9 to Red 9).
- **Chroma Level** – Adjusts how saturated colors appear (-9 to +9).
- **BNR** – Switches on/off block noise reduction (On, Off (default)).

Adjust the Brightness, Contrast, Hue and Chroma Level settings using the ◀/▶ (cursor left/right) buttons.



3

Press ENTER to save your settings and exit the Video Adjust screen.



Note:

- Depending on your TV, the picture may appear distorted if the brightness is set too high. If this happens, lower the brightness.

1



Press SETUP and select “Video Adjust” from the on-screen display.

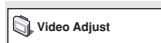

2



Make settings using the ▲/▼/◀/▶ (cursor) buttons, and ENTER.

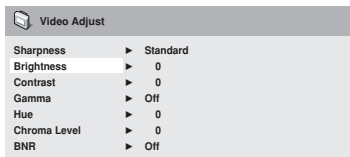

You can adjust the following picture quality settings:

- **Sharpness** – Adjusts the sharpness of edges in the picture (Fine, Standard, Soft).
- **Brightness** – Adjusts the overall brightness (-20 to +20).
- **Contrast** – Adjusts the contrast between light and dark (-16 to +16).
- **Gamma** – Adjusts the “warmth” of the picture (High, Medium, Low, Off).

Initial Settings menu

Using the Initial Settings menu

The Initial Settings menu provides audio and video output settings, parental lock settings, and display settings, among others.

If an option is grayed out it means that it cannot be changed at the current time. This is usually because a disc is playing. Stop the disc, then change the setting.

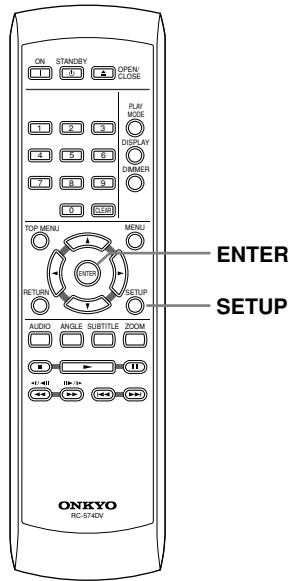

1

SETUP



Press **SETUP** and select "Initial Settings".



2



Use the cursor buttons and **ENTER** to select the setting and option you want to set.

All the settings and options are explained on the following pages.

Notes:

- In the table on next pages, the default setting is shown in **bold**; other settings are shown in *italics*.
- The Digital Audio Out settings only need to be set if you have connected the digital output of this player to an AV receiver, or other equipment.
- Check the operating instructions supplied with your other equipment to see which digital audio formats it's compatible with.
- Some settings, such as TV Screen, Audio Language and Subtitle Language may be overridden by the DVD disc. Often these settings can also be made from the DVD disc menu.

Initial Settings menu—Continued

Digital Audio Out settings

Setting	Option	What it means
Digital Out	On	Digital audio is output from the digital outputs. Note that there is no digital output when playing SACDs and some DVD-Audio discs regardless of this setting.
	Off	No digital audio output.
Dolby Digital Out	Dolby Digital	Dolby Digital encoded digital audio is output when playing a Dolby Digital DVD disc.
	Dolby Digital > PCM	Dolby Digital audio is converted to PCM audio before being output.
DTS Out	DTS	DTS encoded digital audio is output when playing a DTS disc. (Noise will be output if your amplifier/receiver is not compatible with DTS audio.)
	DTS > PCM	DTS audio is converted to PCM audio before being output.
Linear PCM Out	Down Sample On	96kHz digital audio is converted to 48kHz for digital output. Note that High sampling rate DVD-Audio discs (192kHz or 176.4kHz) automatically output down-sampled audio through the digital outputs.
	Down Sample Off	96kHz digital audio is output as is at 96kHz.
MPEG Out	MPEG > PCM	MPEG encoded digital audio is converted to PCM audio for digital output.
	MPEG	MPEG encoded digital audio is output as is.

Video Output settings

Setting	Option	What it means
TV Screen (See also "Screen sizes and disc formats" on page 54.)	4:3 (Letter Box)	Set if you have a conventional 4:3 TV. Widescreen movies are shown with black bars top and bottom.
	4:3 (Pan & Scan)	Set if you have a conventional 4:3 TV. Widescreen movies are shown with the sides cropped so that the image fills the screen.
	16:9 (Wide)	Set if you have a widescreen TV.
Component Out	Progressive	Set if your TV is compatible with progressive scan video (see your TV's instruction manual for details). See also "Switching the video output to interlace using the front panel controls" on page 21. Note that progressive scan video is only output from the component video jacks.
	Interlace	Set if your TV is not compatible with progressive scan video.
AV Connector Out (European model only)	Video	Ordinary (composite) video output, compatible with all TVs.
	S Video	Almost the same quality as RGB, but can give better results if you're using a long SCART cable.
	RGB	If your TV is compatible, this setting gives the best picture quality.

Initial Settings menu—Continued

Language settings

Setting	Option	What it means
Audio Language *1	English	If there is an English soundtrack on the disc then it will be played.
	Languages as displayed	If there is the language selected on the disc, then it will be played.
	Other Language	Select to choose a language other than the ones displayed (see page 56).
Subtitle Language *2	English	If there is are English subtitles on the disc then they will be displayed.
	Languages as displayed	If there is the subtitle language selected on the disc, then it will be displayed.
	Other Language	Select to choose a language other than the ones displayed (see page 56).
DVD Menu Language *3	w/Subtitle Lang.	DVD disc menus will be displayed in the same language as your selected subtitle language, if possible.
	Languages as displayed	DVD disc menus will be displayed in the selected language, if possible.
	Other Language	Select to choose a language other than the ones displayed (see page 56).
Subtitle Display	On	Subtitles are displayed according to your selected subtitle language (see above).
	Off	Subtitles are always off by default when you play a DVD disc (note that some discs override this setting).

*1 This setting is your preferred audio language for DVD discs.

You can switch between the languages recorded on a DVD disc during playback using the AUDIO button.

Some DVD discs set the audio language automatically when loaded, overriding the "Audio Language" setting.

Discs with two or more audio languages usually allow you to select the audio language from the disc menu. Press MENU to access the disc menu.

*2 This setting is your preferred subtitle language for DVD discs.

You can change or switch off the subtitles on a DVD disc during playback using the SUBTITLE button.

Some DVD discs set the subtitle language automatically when loaded, overriding the "Subtitle Language" setting.

Discs with two or more subtitle languages usually allow you to select the subtitle language from the disc menu. Press MENU to access the disc menu.

*3 Some multilingual discs have disc menus in several languages. This setting specifies in which language the disc menus should appear. Leave on the default setting for menus to appear in the same language as your "Subtitle Language".

Display settings

Setting	Option	What it means
OSD Language	English	On-screen displays of the player are in English.
	Languages as displayed	On-screen displays are shown in the language selected.
Angle Indicator	On	A camera icon is displayed on-screen during multi-angle scenes on a DVD disc.
	Off	No multi-angle indication is shown.

Initial Settings menu—Continued

Options settings

Setting	Option	What it means
Parental Lock	–	See “Parental Lock” on page 50.
DVD Playback Mode	DVD-Audio	All material on a DVD-Audio disc is playable.
	DVD-Video	Only the DVD-Video part of a DVD-Audio disc is playable.
SACD Playback	2ch Area	Selects the 2 channel (stereo) SACD audio area of the disc for playback.
	Multi-ch Area	Selects the multi-channel SACD audio area of the disc for playback.
	CD Area	Selects the standard CD audio area of an SACD/CD hybrid disc for playback.
DTS Downmix	Stereo	Downmixes DTS for 2 channel output to regular stereo. (See also “DTS Downmix” on page 52.)
	Lt/Rt	Downmixes DTS for 2 channel output to be compatible with Dolby Surround matrix decoders. (See also “DTS Downmix” on page 52.)
DivX VOD (not North American model)	Display	Selects to display a DivX VOD registration code.

Speakers settings

Setting	Option	What it means
Audio Output Mode	2 Channel	The player outputs analog audio in stereo only. See also “Audio Output Mode” on page 52.
	5.1 Channel	The player outputs 5.1 channel analog audio. See also “Audio Output Mode” on page 52.
Speaker Distance	–	Specify the distance of your speakers from your listening position. See also “Speaker Distance” on page 53.
Speaker Installation	–	Specify the number and size of speakers in your system. See also “Speaker Installation” on page 52.

Initial Settings menu—Continued

About the audio output settings

The table below shows how the audio settings you make in the Initial Settings menu (see page 46) affect the output from the 2 channel and the 5.1 channel analog outputs, and from the digital outputs with various types of disc.

Disc audio format	Player setting	Front L/R analog outputs ^{*1}	Surround L/R Center, LFE, outputs ^{*1}	Digital outputs PCM convert ^{*2}	Bitstream ^{*3}	
DVD	Dolby Digital	2 Ch	2ch downmix	–	2ch downmix	Dolby Digital
		5.1 Ch	Front L / R	Surround L/R, Center, LFE		
	Dolby Digital karaoke	2 Ch / 5.1 Ch	Left / Right	–	Left / Right	Dolby Digital
	Linear PCM	2 Ch / 5.1 Ch	Left / Right	–	Left / Right	Left / Right
	DTS	2 Ch	2ch downmix	–	2ch downmix	DTS
		5.1 Ch	Front L / R	Surround L/R, Center, LFE		
	MPEG	2 Ch	Left / Right	–	Left / Right	MPEG
		5.1 Ch	Front L / R	Surround L/R, Center, LFE		
	DVD-Audio	2 Ch	2ch downmix ^{*4}	–	2ch downmix ^{*5}	2ch downmix ^{*5}
		5.1 Ch	Front L / R	Surround L/R, Center, LFE	–	–
DVD-RW (VR mode)	2 Ch / 5.1 Ch	Left / Right ^{*6}	–	Left / Right	Dolby Digital MPEG or PCM	
Super Audio CD	2 Ch	2ch downmix	–	–	–	
	5.1 Ch	Front L / R	Surround L/R, Center, LFE			
CD	2 Ch / 5.1 Ch	Left / Right	–	Left / Right	Left / Right	
DTS CD	2 Ch	2ch downmix	–	2ch downmix	DTS	
	5.1 Ch	Front L / R	Surround L/R, Center, LFE			
Video CD	2 Ch / 5.1 Ch	Left / Right	–	Left / Right	Left / Right	

*1 When Audio Output Mode is set to 2 Channel, the AUDIO OUT (5.1ch) FRONT L/R jacks act as a second pair of stereo audio outputs.

*2 Dolby Digital > PCM, MPEG > PCM or DTS > PCM setting (page 46)

*3 Dolby Digital, MPEG or DTS setting (page 46)

*4 Discs that prohibit downmixing will be output as 5.1 channel even if 2 Channel is selected as the Audio Output Mode setting (see page 52).

*5 Discs that prohibit downmixing also mute the digital output.

*6 When Audio Output Mode is set to 5.1 Channel, mono sources are heard from the center speaker only.

Initial Settings menu—Continued

Parental Lock

- Default level: Off; Default password: none; Default Country code: us (2119)

To give you some control over what your children watch on your DV-SP502/DV-SP502E, some DVD-Video discs feature a Parental Lock level. If your player is set to a lower level than the disc, the disc won't play.



Some discs also support the Country Code feature. The player does not play certain scenes on these discs, depending on the Country Code you set.

Notes:

- Not all discs use Parental Lock, and will play without requiring the password first.
- If you forget your password, you'll need to reset the player to register a new password. (see page 55)

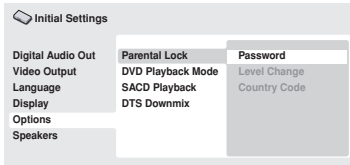

Registering a new password

You must register a password before you can change the Parental Lock level or enter a Country code.



1	<p>Select "Password".</p> 
2	<p>Use the number buttons to enter a 4-digit password.</p> <p>The numbers you enter show up as asterisks (*) on-screen.</p> 
3	<p>Press ENTER to register the password.</p> <p>You will return to the Options menu screen.</p> 

Changing your password

To change your password, confirm your existing password then enter a new one.

1	<p>Select "Password Change".</p>
2	<p>Use the number buttons to enter your existing password, then press ENTER.</p> 
3	<p>Enter a new password and press ENTER.</p> <p>This registers the new password and you will return to the Options menu screen.</p> 

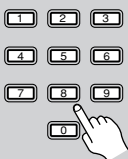
Setting/changing the Parental Lock

1	<p>Select "Level Change".</p>
2	<p>Use number buttons to enter your password, then press ENTER.</p> 
3	<p>Select a new level and press ENTER.</p> <ul style="list-style-type: none"> • Press ◀ (cursor left) repeatedly to lock more levels (more discs will require the password); press ▶ (cursor right) to unlock levels. You can't lock level 1. <p>This sets the new level and you will return to the Options menu screen.</p> 

Initial Settings menu—Continued

Setting/changing the Country code

You can find the Country code list in the adjacent column.

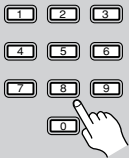
1	Select "Country Code".
2	<p>Use number buttons to enter your password, then press ENTER.</p> 
3	<p>Select a Country code and press ENTER.</p> <p>There are two ways you can do this:</p> <ul style="list-style-type: none"> • Select by code letter: Use ▲/▼ (cursor up/down) to change the Country code. • Select by code number: Press ► (cursor right) then use the number buttons to enter the 4-digit Country code. <p>The new Country code is set and you will return to the Options menu screen. Note that the new Country code doesn't take effect until the next disc is loaded (or the current disc is reloaded).</p>

Country code list

Country	Country code	Country code letter
Argentina	0118	ar
Australia	0121	au
Austria	0120	at
Belgium	0205	be
Brazil	0218	br
Canada	0301	ca
Chile	0312	cl
China	0314	cn
Denmark	0411	dk
Finland	0609	fi
France	0618	fr
Germany	0405	de
Hong Kong	0811	hk
India	0914	in
Indonesia	0904	id
Italy	0920	it
Japan	1016	jp
Korea, Republic of	1118	kr
Malaysia	1325	my
Mexico	1324	mx
Netherlands	1412	nl
New Zealand	1426	nz
Norway	1415	no
Pakistan	1611	pk
Philippines	1608	ph
Portugal	1620	pt
Russian Federation	1821	ru
Singapore	1907	sg
Spain	0519	es
Sweden	1905	se
Switzerland	0308	ch
Taiwan	2023	tw
Thailand	2008	th
United Kingdom	0702	gb
USA	2119	us

Initial Settings menu—Continued

DTS Downmix

Default setting: STEREO

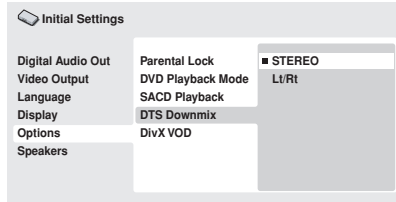

If you've selected DTS > PCM in DTS Out on page 46 or 2 Channel in Audio Output Mode below section, you can choose the way the signal is downmixed to PCM audio. Stereo will downmix the DTS signal to 2-channel stereo, whereas Lt/Rt will downmix to a 2-channel signal compatible with Dolby surround matrix decoders. (This allows you to hear surround sound if your AV receiver or amplifier has Dolby Pro Logic capability.)

Audio Output Mode

Default setting: 2 Channel

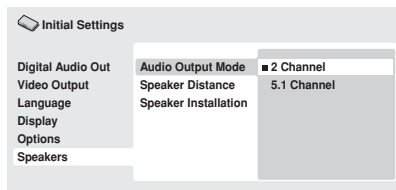

If you connected this player to your amplifier using the 5.1 channel analog outputs (front, surround, center and subwoofer outs), set this to 5.1 Channel; if you connected only the stereo outs, set to 2 Channel.

Notes:

- Even if you set Audio Output Mode to 5.1 Channel, you'll only get sound from all speakers when playing a 5.1 channel multichannel disc.
- When set to 5.1 Channel, only the front left/right channels are output from the AUDIO OUT (2ch) jacks. Change to 2 Channel if you want to listen to downmixed stereo audio (for example, because you are listening through the TV's built-in speakers).
- When set to 5.1 Channel there is no digital output when playing DVD-Audio.
- If you set to 2 Channel, Dolby Digital, DTS and MPEG audio is mixed down to two channels so you still hear all the audio recorded on the disc. With DTS encoded audio, you can choose how the signal is downmixed to PCM audio. See DTS Downmix above to change the downmix setting.
- Some DVD-Audio discs don't allow downmixing of audio. These discs always output multi-channel audio regardless of the setting made here.

Speaker Installation

Default settings: L/R: Large, C: Large, LS/RS: Large, SW: On

You only need to make this setting if you connected this player to your amplifier using the 5.1 channel analog outputs.

This setting does not affect digital audio output.

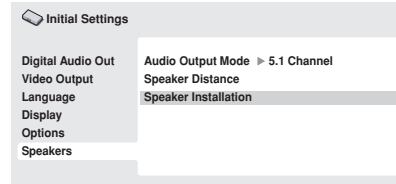

Use the Speaker Installation screen to tell the player what kinds of speakers you have connected.

1



Use the ▲/▼ (cursor up/down) buttons to select a speaker.

- The L and R, and RS and LS speakers are paired; you can't set them differently.

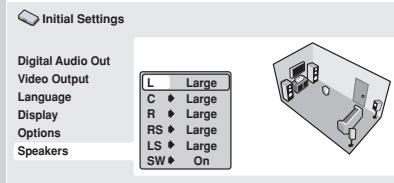

2

Press ► (cursor right) to modify the selected speaker.

3



Use the ▲/▼ (cursor up/down) buttons to change the current setting.

- You can see the effect of your changes in the room graphic on the right of the screen.
- Except for the subwoofer, you can set speaker size to Large or Small. If the main speaker cone in the speaker is 12cm or more, set to Large, otherwise set to Small (or Off if you don't have that speaker).
- If you set the front L and R speakers to Small, the center and surround speakers are automatically set to Small and the subwoofer to On.
- The subwoofer can only be set to On or Off.

Initial Settings menu—Continued

- 4** Press ◀ (cursor left) to go back to the speaker list if you want to modify another speaker, or press ENTER to exit the Speaker Installation screen.

Speaker Distance

You only need to make this setting if you connected this player to your amplifier using the 5.1 channel analog outputs.

These settings do not affect any digital audio output.

To get the best surround sound from your system, you should set up the speaker distances from your listening position.

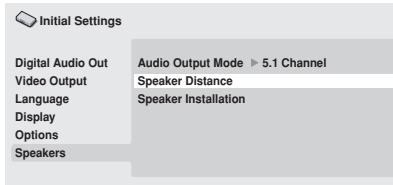

- 1** Use the ▲/▼ (cursor up/down) to select a speaker.



- The L and R speakers are paired; you can't set them differently.

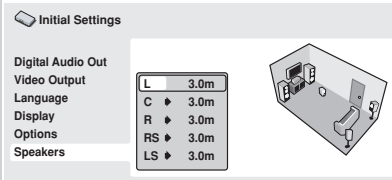

- 2** Press ▶ (cursor right) to change the speaker distance for the highlighted speaker.

- 3** Use the ▲/▼ (cursor up/down) to change the distance.



- When you change the distance settings of the front left (L) or front right (R) speakers, all the other speaker distances change relative to it.
- Front left/right (L/R) speaker distances can be set from 1 ft (30 cm) to 10 ft (9 m) in 1 ft (30 cm) increments.
- The center speaker (C) can be set from -7 ft (-2.1 m) to 0 ft (0 m) relative to the front left/right speakers.

- Surround left/right (LS/RS) speakers can be set from -20 ft (-6.0 m) to 0 ft (0 m) relative to the front left/right speakers.
- You can't set the subwoofer (SW) distance.

- 4** Press ◀ (cursor left) to go back to the speaker list if you want to modify another speaker, or press ENTER to exit the Speaker Distance screen.

Note:

- During playback of SACD and MPEG-audio DVD-Video discs, the effective C, LS and RS speaker distance settings are -3 ft (-0.9m) to 0 ft (0 m) relative to the front left/right speakers.

Additional information

Screen sizes and disc formats

DVD-Video discs come in several different screen aspect ratios, ranging from TV programs, which are generally 4:3, to Cinema- Scope widescreen movies, with an aspect ratio of up to about 7:3.

Televisions, too, come in different aspect ratios; “standard” 4:3 and widescreen 16:9.

Widescreen TV users

If you have a widescreen TV, the TV Screen setting (page 46) of this player should be set to “16:9 (Wide)”. When you watch discs recorded in 4:3 format, you can use the TV controls to select how the picture is presented. Your TV may offer various zoom and stretch options; see the instructions that came with your TV for details.

Please note that some movie aspect ratios are wider than 16:9, so even though you have a widescreen TV, these discs will still play in a “letter box” style with black bars at the top and bottom of the screen.

Standard TV users

If you have a standard TV, the “TV Screen” setting (page 46) of this player should be set to “4:3 (Letter Box)” or “4:3 (Pan&Scan)”, depending on which you prefer.

Set to “4:3 (Letter Box)”, widescreen discs are shown with black bars top and bottom.



Set to “4:3 (Pan&Scan)”, widescreen discs are shown with the left and right sides cropped.

Although the picture looks larger, you don’t actually see the whole picture.



Please note that many widescreen discs override the player’s settings so that the disc is shown in letter box format regardless of the setting.

Note:

- Using the “16:9 (Wide)” setting with a standard 4:3 TV, or either of the “4:3” settings with a widescreen TV, will result in a distorted picture.

Setting the TV system (Not North American model)

The default setting of this player is AUTO, and unless you notice that the picture is distorted when playing some discs, you should leave it set to AUTO. If you experience picture distortion with some discs, set the TV system to match your country or region’s system. Doing this, however, may restrict the kinds of disc you can watch. The table below shows what kinds of disc are compatible with each setting (AUTO, PAL and NTSC).

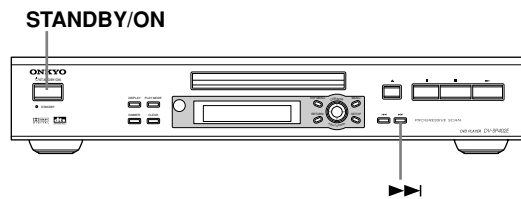

1 If the player is on, press **STANDBY/ON** to switch it to standby.

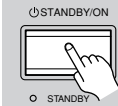

2 Using the front panel controls, hold down **▶▶** then press **STANDBY/ON** to switch the TV system.

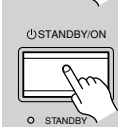

The TV system changes as follows:

- AUTO → NTSC
- NTSC → PAL
- PAL → AUTO

Note:

- You have to switch the player into standby (press STANDBY/ON) before each change.

Disc		Player setting		
Type	Format	NTSC	PAL	AUTO
DVD/ Super VCD	NTSC	NTSC	PAL	NTSC
	PAL	NTSC	PAL	PAL
Video CD	NTSC	NTSC	PAL	NTSC
	PAL	NTSC	PAL	PAL
CD/SACD no disc	-	NTSC	PAL	NTSC or PAL

Additional information—Continued

Resetting the player

Use this procedure to reset all the player's settings to the factory default.

- 1** Switch the player into standby.
- 2** Using the front panel buttons, hold down the  button and press **STANDBY/ON** to switch the player back on.
All the player's settings are now reset.

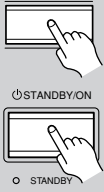

DVD-Video regions

All DVD-Video discs carry a region mark on the case somewhere that indicates which region(s) of the world the disc is compatible with. Your DV-SP502/DV-SP502E also has a region mark, which you can find on the rear panel. Discs from incompatible regions will not play in this player. Discs marked "ALL" will play in any player. The diagram below shows the various DVD regions of the world.

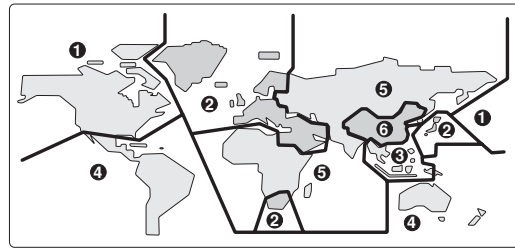

Titles, chapters and tracks

DVD discs are generally divided into one or more titles. Titles may be further subdivided into chapters.

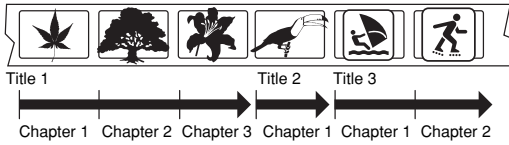

SACDs, CDs and Video CDs are divided into tracks.

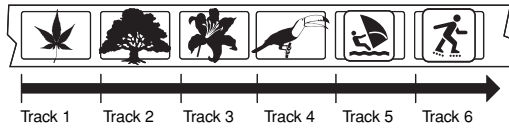

CD-ROMs contain folders and files. MP3 and WMA files are referred to as tracks. Folders may contain further folders.

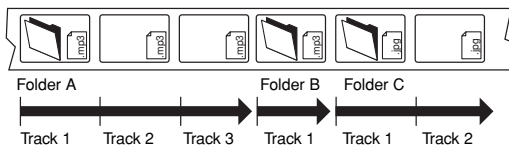



Additional information—Continued

Selecting languages using the language code list

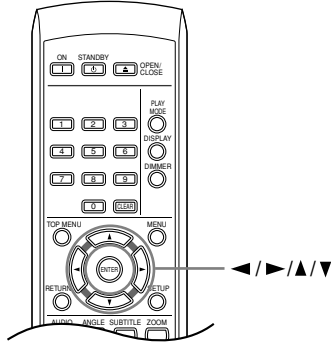
Some of the language options (such as “DVD Language” in the Setup Navigator) allow you to set your preferred language from any of the 136 languages listed in the language code list on page 57.



1	Select “Other Language”.
2 	Use the ◀/▶ (cursor left/right) buttons to select either a code letter or a code number.
3 	Use the ▼/▲ (cursor up/down) buttons to select a code letter or a code number. See “Language code list” on page 57 for a complete list of languages and codes.

Additional information—Continued

Language code list



Language	Language code letter	Language code	Language	Language code letter	Language code	Language	Language code letter	Language code
Japanese	ja	1001	Hungarian	hu	0821	Sangho	sg	1907
English	en	0514	Armenian	hy	0825	Serbo-Croatian	sh	1908
French	fr	0618	Interlingua	ia	0901	Sinhalese	si	1909
German	de	0405	Interlingue	ie	0905	Slovak	sk	1911
Italian	it	0920	Inupiak	ik	0911	Slovenian	sl	1912
Spanish	es	0519	Indonesian	in	0914	Samoan	sm	1913
Chinese	zh	2608	Icelandic	is	0919	Shona	sn	1914
Dutch	nl	1412	Hebrew	iw	0923	Somali	so	1915
Portuguese	pt	1620	Yiddish	ji	1009	Albanian	sq	1917
Swedish	sv	1922	Javanese	jw	1023	Serbian	sr	1918
Russian	ru	1821	Georgian	ka	1101	Siswati	ss	1919
Korean	ko	1115	Kazakh	kk	1111	Sesotho	st	1920
Greek	el	0512	Greenlandic	kl	1112	Sundanese	su	1921
Afar	aa	0101	Cambodian	km	1113	Swahili	sw	1923
Abkhazian	ab	0102	Kannada	kn	1114	Tamil	ta	2001
Afrikaans	af	0106	Kashmiri	ks	1119	Telugu	te	2005
Amharic	am	0113	Kurdish	ku	1121	Tajik	tg	2007
Arabic	ar	0118	Kirghiz	ky	1125	Thai	th	2008
Assamese	as	0119	Latin	la	1201	Tigrinya	ti	2009
Aymara	ay	0125	Lingala	ln	1214	Turkmen	tk	2011
Azerbaijani	az	0126	Laothian	lo	1215	Tagalog	tl	2012
Bashkir	ba	0201	Lithuanian	lt	1220	Setswana	tn	2014
Byelorussian	be	0205	Latvian	lv	1222	Tonga	to	2015
Bulgarian	bg	0207	Malagasy	mg	1307	Turkish	tr	2018
Bihari	bh	0208	Maori	mi	1309	Tsonga	ts	2019
Bislama	bi	0209	Macedonian	mk	1311	Tatar	tt	2020
Bengali	bn	0214	Malayalam	ml	1312	Twi	tw	2023
Tibetan	bo	0215	Mongolian	mn	1314	Ukrainian	uk	2111
Breton	br	0218	Moldavian	mo	1315	Urdu	ur	2118
Catalan	ca	0301	Marathi	mr	1318	Uzbek	uz	2126
Corsican	co	0315	Malay	ms	1319	Vietnamese	vi	2209
Czech	cs	0319	Maltese	mt	1320	Volapük	vo	2215
Welsh	cy	0325	Burmese	my	1325	Wolof	wo	2315
Danish	da	0401	Nauru	na	1401	Xhosa	xh	2408
Bhutani	dz	0426	Nepali	ne	1405	Yoruba	yo	2515
Esperanto	eo	0515	Norwegian	no	1415	Zulu	zu	2621
Estonian	et	0520	Occitan	oc	1503			
Basque	eu	0521	Oromo	om	1513			
Persian	fa	0601	Oriya	or	1518			
Finnish	fi	0609	Panjabi	pa	1601			
Fiji	fj	0610	Polish	pl	1612			
Faroese	fo	0615	Pashto,Push to	ps	1619			
Frisian	fy	0625	Quechua	qu	1721			
Irish	ga	0701	Rhaeto-Romance	rm	1813			
Scots-Gaelic	gd	0704	Kirundi	rn	1814			
Galician	gl	0712	Romanian	ro	1815			
Guarani	gn	0714	Kinyarwanda	rw	1823			
Gujarati	gu	0721	Sanskrit	sa	1901			
Hausa	ha	0801	Sindhi	sd	1904			
Hindi	hi	0809						
Croatian	hr	0818						

Using the Remote controller with Other Brand's TVs (North American model only)

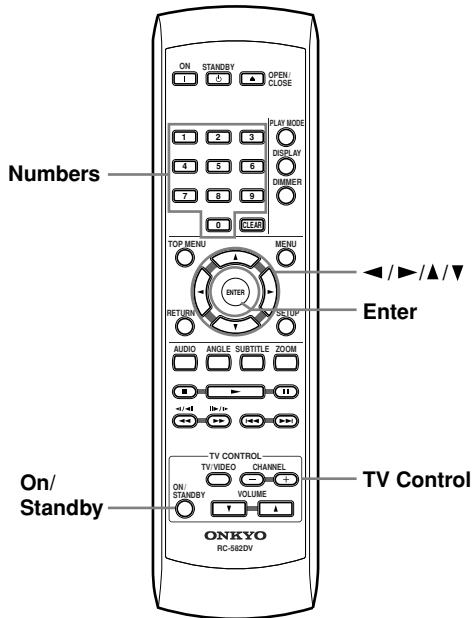
Learning a pre-programming code



You can make RC-582DV remote controller to operate a TV from other brand than Onkyo by storing the pre-programming code of the brand in the RC-582DV.

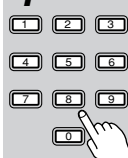

1	Find the 3-digit number for the brand name of the component that you want to operate in the table on page 59.
2	Turn on the TV that you want to operate.
3 	While holding down the ON/STANDBY on the RC-582DV that you want to program, press Enter, and then release both buttons. (Make sure you press ON/STANDBY before Enter.) 
4 	Within 10 seconds, enter the 3-digit code number. 

5	Press some operation buttons for the component that you want to operate to check if the system operates properly. If the system operates properly, the code is correct. If the component does not operate properly, return to step 2.
----------	---

Notes:

- With some brand's components, some buttons may not work correctly.
- If more than one code is given in the table, try the code one by one until you reach the code for your component (i.e. if the first code does not work, then try the next).
- The code can be retained by changing the batteries within 1 minute. If the code is lost, store the pre-programming code again.

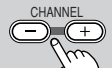
Controlling a TV

1 	Press ON/STANDBY to turn on the device.
2   	Press the desired operation button. + : Changes the TV channel upward. - : Changes the TV channel downward. ▲ : Increases the TV volume. ▼ : Decrease the TV volume. TV/VIDEO: Switches the TV/VCR inputs.

Using the Remote controller with Other Brand's TVs (North American model only)—Continued

Pre-programming Code List

Brand	Code
AIWA	100, 101
AKAI	102, 103, 104
AUDIO SONIC	105
BELL&HOWELL	106
BLAUPUNKT	107
BRIONVEGA	108, 109
CENTURION	110
COLTINA	111, 112, 113
CORONAD	114
CROWN	115, 116
DAEWOO	117, 118, 119, 120, 121
DUAL	122
EMERSON	123, 124, 125, 126, 127
FENNER	128, 129
FERGUSON	130, 131
FISHER	132
FUNAI	133, 134, 135
FUJITSU GENERAL	136, 137, 138
GE • PANA	139, 140
GE • RCA	141
GOLD STAR	142, 143
GOODMANS	144
GRUNDIG	145, 146
HITACHI	147, 148, 149, 150
HYPER	151
INNO-HIT	152
IRRADIO	103
JVC	153, 154, 155, 156, 157
KENDO	158
KTV	159, 160
LUXOR	161
MAGNAVOX	162, 163
MARANTZ	164
MARK	165
MATSUI	166, 167, 168, 169
MITSUBISHI	170, 171, 172, 173
MIVAR	174, 175
NEC	176, 177
NOKIA	178, 179, 180, 181
NOKIA OCEANIC	181
NORDMENDE	182, 183
OKANO	152
ORION	184, 185, 186
PANASONIC	187, 188, 189, 190
PHILIPS	162, 191, 152
PIONEER	192, 193
PROSCAN	194
QUASAR	195
RADIOHARK	196
RCA	141, 197, 198, 110, 199, 200

Brand	Code
SABA	201, 182, 183
SAMSUNG	202, 203, 204, 205, 206, 207, 208
SANYO	209, 210, 211, 212
SCHNEIDER	103
SEARS	213
SELECO	214, 215
SHARP	216, 217
SONY	218, 219, 220, 221, 222, 223
SYMPHONIC	224, 225
TELEFUNKEN	201, 226, 227
THOMSON	228
TOSHIBA	213, 229
UNIVERSUM	230
ZENITH	231, 232

DivX Titles

Onkyo has tested and verified on the DV-SP502 the correct playback of DivX titles that consist of one of the following combinations of video and audio data.

Video				Audio		
resolution	color	code	frame rate	audio code	sampling frequency	channel bit rate
640x272	24Bit	DivX 5.1	23.98fps	MPEG1-LayerIII	44.10kHz	2ch 128kbps
640x304	24Bit	DivX 5.1	23.98fps	MPEG1-LayerIII	44.10kHz	2ch 128kbps
640x480	24Bit	DivX 5.1	23.98fps	MPEG1-LayerIII	44.10kHz	2ch 128kbps
720x576	24Bit	DivX 5.1	25.00fps	MPEG1-LayerIII	48.00kHz	2ch 189kbps
720x576	24Bit	DivX 5.1	25.00fps	MPEG1-LayerIII	48.00kHz	2ch 189kbps
720x320	24Bit	DivX 5.1	23.98fps	MPEG1-LayerIII	48.00kHz	2ch 320kbps
720x320	24Bit	DivX 5.1	23.98fps	MPEG1-LayerIII	48.00kHz	2ch 320kbps
640x272	24Bit	DivX 5.0.5	23.98fps	MPEG1-LayerIII	11.03kHz	2ch 32kbps
640x272	24Bit	DivX 5.0.5	23.98fps	MPEG1-LayerIII	22.05kHz	2ch 64kbps
640x272	24Bit	DivX 5.0.5	23.98fps	MPEG1-LayerIII	32.00kHz	2ch 83kbps
200x100	24Bit	DivX 5.0.5	23.98fps	MPEG1-LayerIII	44.10kHz	2ch 128kbps
320x240	24Bit	DivX 5.0.5	23.98fps	MPEG1-LayerIII	44.10kHz	2ch 128kbps
352x288	24Bit	DivX 5.0.5	23.98fps	MPEG1-LayerIII	44.10kHz	2ch 128kbps
484x264	24Bit	DivX 5.0.5	23.98fps	MPEG1-LayerIII	44.10kHz	2ch 128kbps
484x264	24Bit	DivX 4.1.2	23.98fps	MPEG1-LayerIII	44.10kHz	2ch 128kbps
512x288	24Bit	DivX 5.0.5	23.98fps	MPEG1-LayerIII	44.10kHz	2ch 128kbps
576x320	24Bit	DivX 5.0.5	23.98fps	MPEG1-LayerIII	44.10kHz	2ch 128kbps
640x272	24Bit	DivX 5.0.5	23.98fps	MPEG1-LayerIII	44.10kHz	2ch 128kbps
640x304	24Bit	DivX 5.0.5	23.98fps	MPEG1-LayerIII	44.10kHz	2ch 128kbps
640x304	24Bit	DivX 5.0.2	23.98fps	MPEG1-LayerIII	44.10kHz	2ch 128kbps
640x304	16Bit	DivX 4.1.2	23.98fps	MPEG1-LayerIII	44.10kHz	2ch 128kbps
640x352	24Bit	DivX 5.0.5	23.98fps	MPEG1-LayerIII	44.10kHz	2ch 128kbps
640x352	24Bit	DivX 5.0.5	23.98fps	MPEG1-LayerIII	44.10kHz	2ch 128kbps
640x352	24Bit	DivX 5.0.5	23.98fps	MPEG1-LayerIII	44.10kHz	2ch 128kbps
640x352	24Bit	DivX 5.0.5	23.98fps	MPEG1-LayerIII	44.10kHz	2ch 128kbps
640x352	24Bit	DivX 5.0.5	23.98fps	MPEG1-LayerIII	44.10kHz	2ch 128kbps
640x352	24Bit	DivX 5.0.5	23.98fps	MPEG1-LayerIII	44.10kHz	2ch 128kbps
640x352	24Bit	DivX 5.0.5	23.98fps	MPEG1-LayerIII	44.10kHz	2ch 128kbps
640x352	24Bit	DivX 5.0.5	23.98fps	MPEG1-LayerIII	44.10kHz	2ch 128kbps
640x352	24Bit	DivX 5.0.5	23.98fps	MPEG1-LayerIII	44.10kHz	2ch 128kbps
640x480	24Bit	DivX 5.0.3	11.99fps	MPEG1-LayerIII	44.10kHz	2ch 128kbps
640x480	24Bit	DivX 5.0.3	7.99fps	MPEG1-LayerIII	44.10kHz	2ch 128kbps
640x272	24Bit	DivX 5.0.5	23.98fps	MPEG1-LayerIII	48.00kHz	1ch 64kbps
640x272	24Bit	DivX 5.0.5	23.98fps	MPEG1-LayerIII	48.00kHz	2ch 115kbps
640x352	24Bit	DivX 5.0.5	23.98fps	MPEG1-LayerIII	48.00kHz	2ch 129kbps
640x352	24Bit	DivX 5.0.5	23.98fps	MPEG1-LayerIII	48.00kHz	2ch 129kbps
640x272	24Bit	DivX 5.0.5	23.98fps	MPEG1-LayerIII	48.00kHz	2ch 320kbps

DivX Titles—Continued

Video				Audio		
resolution	color	code	frame rate	audio code	sampling frequency	channel bit rate
640x272	24Bit	DivX 5.0.5	23.98fps	MPEG1Audio	48.00kHz	2ch 192kbps
640x352	24Bit	DivX 5.0.5	23.98fps	Dolby AC-3	48.00kHz	5ch 448kbps
640x352	24Bit	DivX 5.0.5	23.98fps	PCM	48.00kHz 16Bit	2ch 1536kbps
640x304	24Bit	DivX 3.11	23.98fps	MPEG1-LayerIII	44.10kHz	2ch 127kbps
320x240	24Bit	DivX 3.11	23.98fps	MPEG1-LayerIII	44.10kHz	2ch 128kbps
484x264	24Bit	DivX 3.11	23.98fps	MPEG1-LayerIII	44.10kHz	2ch 128kbps
640x304	24Bit	DivX 3.11	23.98fps	MPEG1-LayerIII	44.10kHz	2ch 128kbps
640x352	24Bit	DivX 3.11	23.98fps	MPEG1-LayerIII	44.10kHz	2ch 160kbps
640x352	24Bit	DivX 3.11	23.98fps	MPEG1-LayerIII	48.00kHz	2ch 320kbps
640x352	24Bit	DivX 3.11	23.98fps	MPEG1-LayerIII	48.00kHz	2ch 320kbps
720x480	24Bit	DivX 3.11	29.97fps	No Sound		
720x480	24Bit	DivX 5.1	29.97fps	No Sound		
720x480	24Bit	DivX 5.1	29.97fps	No Sound		
720x480	24Bit	DivX 5.1	29.97fps	No Sound		
720x480	24Bit	DivX 5.1	29.97fps	No Sound		
720x480	24Bit	DivX 4.1.2	29.97fps	No Sound		
720x480	24Bit	DivX 5.0.5	29.97fps	No Sound		
720x480	24Bit	DivX 5.0.5	29.97fps	No Sound		
720x480	24Bit	DivX 5.0.5	29.97fps	No Sound		
720x480	24Bit	DivX 5.0.5	29.97fps	No Sound		
720x480	24Bit	DivX 5.0.5	29.97fps	No Sound		
720x480	24Bit	DivX 5.0.5	29.97fps	No Sound		

Note:

- Set the interleave to five seconds or shorter.

Glossary

Analog audio

Direct representation of sound by an electrical signal. See also Digital audio.

Aspect ratio

The width of a TV screen relative to its height. Conventional TVs are 4:3; widescreen models are 16:9.

Bonus Group (DVD-Audio only)

An "extra" group on some DVD-Audio discs that requires a key number to access.

Browsable pictures (DVD-Audio only)

A feature of some DVD-Audio discs in which the user can browse still pictures recorded on the disc as the audio is played. See also Slideshow.

Digital audio

Indirect representation of sound using numbers. See also Sampling frequency and Analog audio.

Dolby Digital

A multi-channel audio encoding system developed by Dolby Laboratories that enables far more audio to be stored on a disc than PCM encoding. See also PCM (Pulse Code Modulation).



DRM

DRM (Digital Rights Management) copy protection is a technology designed to prevent unauthorized copying by restricting playback, etc. of material on devices other than the PC (or other WMA recording equipment) used to record it. For detailed information, please see the instruction manuals or help files that came with your PC (or other WMA recording equipment) and/or software.

DTS

A multi-channel audio encoding system developed by Digital Theater Systems that enables far more audio to be stored on a disc than PCM encoding. See also PCM (Pulse Code Modulation).



EXIF (Exchangeable Image File)

A file format developed by Fuji Photo Film for digital still cameras. Digital cameras from various manufacturers use this compressed file format which carries date, time and thumbnail information, as well as the picture data.

File extension

A tag added to the end of a filename to indicate the type of file. For example, ".mp3" indicates an MP3 file.

ISO 9660 format

International standard for the volume and file structure of CD-ROM discs.

JPEG

A standard file format used for still images. JPEG files are identified by the file extension ".jpg".

MP3

MP3 (MPEG1 audio layer 3) is a compressed stereo audio file format.

Files are recognized by their file extension ".mp3".

MPEG audio

An audio format used on Video CD/ Super VCDs and some DVD discs.

Packed PCM (DVD-Audio only)

A lossless compression system that enables more PCM audio to be stored on a DVD-Audio disc than would otherwise be possible.

PBC (PlayBack Control)

A system of navigating a Video CD/ Super VCD through on-screen menus recorded onto the disc.

PCM (Pulse Code Modulation)

Digital audio encoding system found on CDs. Good quality, but requires a lot of data compared to Dolby Digital, DTS and MPEG encoded audio. See also Digital audio.

Progressive scan video

All the lines that make up a video picture are updated in one pass (compared to interlace which takes two passes to update the whole picture).

Regions (DVD-Video only)

These associate DVD-Video discs and players with particular areas of the world. See DVD-Video regions on page 55 for more information.

Sampling frequency

The rate at which sound is measured to be turned into digital audio data. The higher the rate, the better the sound quality. CD is 44.1 kHz; DVD can be up to 96 kHz. See also Digital audio.

Super Audio CD (SACD)

Super Audio CD is a high quality audio disc format that can accommodate high sampling rate stereo and multi-channel audio, as well as conventional CD audio all on the same disc.

WMA

WMA is short for Windows Media Audio and refers to an audio compression technology developed by Microsoft Corporation. Files are recognized by their file extension ".wma". Microsoft, Windows Media, and the Windows logo are trademarks, or registered trademarks of Microsoft Corporation in the United States and/or other countries.

FAQ

My DV-SP502/DV-SP502E switches on but there is nothing displayed on my TV.

- Make sure that the TV is set to the correct video input (not a TV channel). For example, if you connected this player to the VIDEO 1 inputs on your TV, switch your TV to VIDEO 1.

After I load a DVD disc, it ejects automatically after a few seconds!

- Most likely, the disc is the wrong region for your player. The region number should be printed on the disc; check it against the region number of the player (which you can find on the rear panel). See also “DVD-Video regions” on page 55. If the region number is OK, it may be that the disc is damaged or dirty. Clean the disc and look for signs of damage. See also “Handling Discs” on page 10.

Why won't the disc I loaded play?

- First check that you loaded the disc the right way up (label side up), and that it's clean and undamaged. See “Cleaning Discs” on page 10 for information on cleaning discs.
If a disc loaded correctly won't play, it's probably an incompatible format or disc type, such as DVD-ROM. See “Supported Discs” on page 9 for more on disc compatibility.

I have a widescreen TV so why are there black bars at the top and bottom of the screen when I play some discs?

- Some movie formats are such that even when played on a widescreen TV, black bars are necessary at the top and bottom of the screen. This is not a malfunction.

I have a standard (4:3) TV and set the player to show widescreen DVDs in pan & scan format, so why do I still get black bars top and bottom with some discs?

- Some discs override the display preferences of the player, so even if you have 4:3 (Pan & Scan) selected, those discs will still be shown in letter box format. This is not a malfunction.

My AV receiver is definitely compatible with 96/88.2kHz Linear PCM audio, but it doesn't seem to work with this player. What's wrong?

- For digital copy-protection purposes, some 96/88.2kHz DVD discs only output digital audio downsampled to 48/44.1kHz. This is not a malfunction. To fully take advantage of the high sampling rate audio, connect the analog audio outputs to your amplifier/receiver.

Why can't I hear SACD audio through the digital outputs?

- SACD audio is only available through the analog outputs. This is not a malfunction. Some DVD-Audio discs too only output audio through the analog outputs.

Is it better to listen to DVD-Audio discs through the analog outputs?

- Some DVD-Audio discs do not output anything through the digital outputs, and multichannel discs are downmixed to stereo for the digital output. In addition, high sampling rate DVD-Audio discs (higher than 96kHz) automatically downsample audio output from the digital outputs. Using the multichannel analog audio outputs for DVD-Audio have none of these limitations.

My DVD-Audio disc starts playing, but then suddenly stops!

- The disc may have been illegally copied.

Troubleshooting

If you have any trouble using your DV-SP502/DV-SP502E, check the following table for possible causes and remedies. If you still can't resolve the issue yourself, please contact your Onkyo dealer.

DV-SP502/DV-SP502E

The disc won't play or is automatically ejected after loading.

- Make sure the disc is free from dirt and dust and is not damaged (page 10).
- Make sure the disc is loaded with the label side face-up and aligned properly in the disc tray guide.
- Incompatible region number: If the region number on a DVD-Video disc does not match the number on the player, the disc cannot be used (page 55).
- Condensation inside the player: Allow time for condensation to evaporate. Avoid using the player near an air-conditioning unit.
- Disc is loaded upside down: Reload the disc with the label side face up.

DVD-Audio playback stops.

- The disc may have been illegally copied.

Picture playback stops and the operation buttons cannot be used.

- Press **■**, then start playback again (▶).
- Press and hold the front panel. STANDBY/ON button for about 10 seconds to switch the unit off, then press again to switch back on.
- Switch the power off once, unplug from the wall socket, then plug back in and switch on again using the front panel. STANDBY/ON button.

New settings made in the Setup screen menus while a disc is playing are ineffective.

- Some settings can be changed while a disc is playing, but are not effective until the disc is stopped then restarted: Press **■**, then start playback again (▶).

Settings are canceled.

- When the power is cut due to power failure or by unplugging the power cord, settings will be canceled: Press. STANDBY/ON on the front panel to turn the player off. Wait for --GOOD BYE-- to disappear from the display, then unplug the power cord.

No picture/No color.

- Incorrect video connections: Check that connections are correct and that plugs are inserted fully. Also check the video cable for damage.
- TV/monitor or AV amplifier settings are incorrect: Check the instruction manual of the connected equipment.
- The video output is set to progressive but your TV/monitor is not compatible with progressive scan: See page 21 for how to set to interlace.

Screen is stretched or aspect does not change.

- The TV Screen setting in the Initial Settings menu is incorrect. See page 54 for how to set it correctly for your TV/monitor.

Picture disturbance during playback or the picture is dark.

- This player is compatible with Macro-Vision System copy guard. Some discs include a copy prevention signal, and when this type of disc is played back, stripes etc., may appear on some sections of the picture depending on the TV. This is not a malfunction.
- Due to the player's copy protection circuits, connection of this device through a VCR or an AV selector may prevent recording or cause picture problems. This is not a malfunction.

No audio, or audio is distorted.

- No audio is output during slow motion playback or when scanning discs other than audio CDs and SACDs.
- Some DVD discs do not output digital audio: Switch your amplifier to the player's analog outputs.
- Check that the disc is free from dust and dirt, and that it is not damaged (page 10).
- Check that all interconnects are firmly inserted.
- Check that the plugs and terminals are free of dirt, oxide, etc. and clean if necessary. Also check the cable for damage.
- Make sure the player's output is not connected to the amplifier's phono (turntable) inputs.
- Check your amplifier/receiver's settings (volume, input function, speaker settings, etc.).

Troubleshooting—Continued

The analog audio is OK, but there appears to be no digital audio signal.

- Make sure that the Digital Out setting is set to On (page 46).
- Check that the Dolby Digital, DTS and MPEG out settings (page 46) are suitable for your amplifier/receiver/check the instruction manual that came with your amplifier/receiver.
- SACDs and some DVD-Audio discs do not output digital audio. Listen through the player's analog audio outputs.

Noticeable difference in DVD and CD volume.

- This is due to differences in the audio format and is not a malfunction.

Cannot play multichannel audio

- Make sure that Audio Output Mode is set to 5.1 Channel (page 52).
- Check that the Dolby Digital, DTS and MPEG Out settings (page 46) are suitable for your amplifier/receiver—check the instruction manual that came with your amplifier/receiver.
- DVD-Audio and SACDs do not output multichannel digital audio. Listen through the player's analog outputs.
- Check that the settings in the Speaker Installation screen are correct (page 52).
- Check the audio options available from the disc menu.

Cannot listen to highsampling rate audio through the digital output.

- Make sure that Linear PCM Out is set to Downsample Off (page 46).
- As a copy-protection measure, some DVDs do not output 96kHz audio. In this case, even if set to Downsample Off, the player automatically outputs the audio at 48 kHz. This is not a malfunction.

Cannot output 192kHz or 176.4kHz digital audio.

- The player does not output digital audio at these sampling rates. The digital output is automatically downsampled.

Cannot output 96kHz or 88.2kHz digital audio.

- Check that Linear PCM Out is set to Downsample Off (page 46).
- Some discs are digital copy protected and do not output high sampling rate digital audio. In this case the output is automatically downsampled.

No DTS audio output.

- If this unit is connected to a non-DTS compatible amplifier or decoder using a digital audio cable, set DTS Out to DTS > PCM (page 46). If you do not do this, noise will be output when you play a DTS disc.
- If this unit is connected to a DTS-compatible amplifier or decoder using a digital audio cable, check the amplifier settings, and that the cable is properly connected.

Audio mix does not sound right or sounds incomplete (for example, inaudible dialog).

- Make sure that Audio Output Mode is set to 2 Channel if you've connected to the stereo inputs on your amplifier or TV (page 52).

Troubleshooting—Continued

Remote Controller

Buttons on the DV-SP502/DV-SP502E work OK but those on the remote controller don't?

- There are no batteries in the remote controller.
Install new batteries (page 11).
- The batteries are flat.
Replace with new batteries (page 11).
- The batteries are installed incorrectly.
Check the batteries and correct as necessary (page 11).
- You're not pointing the remote controller at the DV-SP502/DV-SP502E's remote sensor.
Point the remote controller at the DV-SP502/DV-SP502E's remote sensor (page 11).
- You're too far away from the DV-SP502/DV-SP502E.
Use the remote controller closer to the DV-SP502/DV-SP502E (page 11). The remote controller has a range of approximately 16 ft (5 meters).
- A strong light source is interfering with the DV-SP502/DV-SP502E's remote sensor.
Make sure that the DV-SP502/DV-SP502E is not subjected to direct sunshine or inverter-type fluorescent lights. Relocate if necessary.
- If the DV-SP502/DV-SP502E is installed in a cabinet with colored glass doors, the remote controller may not work reliably when the doors are closed.
Open the doors, or use a cabinet without colored glass.

The DV-SP502/DV-SP502E contains a microcomputer for signal processing and control functions. In very rare situations, severe interference, noise from an external source, or static electricity may cause it to lockup. In the unlikely even that this should happen, unplug the power cord from the wall outlet, wait at least five seconds, and then plug it back in again.

Specifications

Signal System	North American model: NTSC European model: PAL/NTSC Asian model: PAL/NTSC	
Composite Video Output/Impedance	1.0 V (p-p)/75 Ω negative sync, RCA	
S Video Output/Impedance	Y: 1.0 V (p-p)/75 Ω negative sync, 4-pin mini DIN C: 0.286 V (p-p)/75 Ω	
Component Video Output/Impedance	Y: 1.0 V (p-p)/75 Ω PB/PR: 0.7 V (p-p)/75 Ω RCA/ phono	
AV Connector (European model only)	1.0 V (p-p)/75 Ω , Scart	
Component Video Frequency Response	5 Hz–50 MHz	
Frequency response	DVD Audio	4 Hz–88 kHz (192 kHz)
	DVD Linear Sound	4 Hz–44 kHz (96kHz) 4 Hz–22 kHz (48kHz)
	Audio CD	4 Hz–20 kHz (44.1kHz)
S/N Ratio	106 dB	
Audio Dynamic Range	96 dB	
THD (Total Harmonic Distortion)	0.003 % (1kHz)	
Wow and Flutter	Below threshold of measurability	
Audio Output (Digital/Optical)	–22.5 dBm	
Audio Output/Impedance (Digital/Coaxial)	0.5 p-p/75 Ω	
Audio Output/Impedance (Analog)	2.0 V (rms)/440 Ω	

■ General

Power Supply	North American model: AC 120 V, 60 Hz European model: AC 100–240 V, 50/60 Hz Asian model: AC 100–240 V, 50/60 Hz
Power Consumption	European model: 12 W North American, Asian model: 11 W
Stand-by Power Consumption	North American model: 0.1 W European model, Asian model: 0.3 W
Dimensions (W x H x D)	435 W x 81 H x 309 D mm (17 1/8 W x 3 3/16 H x 12 3/16 D inches)
Weight	3.4 kg (7.5 lbs)
Operation Condition Temperature/Humidity	5° C–35° C (41 F–95 F)/5 %–85%
Disc Compatibility	SACD, DVD-Audio, DVD-video, DVD-R/RW (VR, VIDEO), CD, CD-R/RW, Video CD, SVCD, WMA, MP3, WMA, JPEG Disc that have not been property finalized may only be partially playable or not playable at all

Specifications and features subject to change without notice.

ONKYO CORPORATION

Sales & Product Planning Div. : 2-1, Nisshin-cho, Neyagawa-shi, OSAKA 572-8540, JAPAN
Tel: 072-831-8023 Fax: 072-831-8124

ONKYO U.S.A. CORPORATION

18 Park Way, Upper Saddle River, N.J. 07458, U.S.A.
Tel: 201-785-2600 Fax: 201-785-2650 <http://www.onkyousa.com>

ONKYO EUROPE ELECTRONICS GmbH

Liegnitzerstrasse 6, 82194 Groebenzell, GERMANY
Tel: +49-8142-4401-0 Fax: +49-8142-4401-555 <http://www.onkyo.net>

ONKYO EUROPE UK Office

Suite 1, Gregories Court, Gregories Road, Beaconsfield, Buckinghamshire, HP9 1HQ
UNITED KINGDOM Tel: +44-(0)1494-681515 Fax: +44(0)-1494-680452

ONKYO CHINA LIMITED

Units 2102-2107, Metroplaza Tower I, 223 Hing Fong Road, Kwai Chung,
N.T., HONG KONG Tel: 852-2429-3118 Fax: 852-2428-9039



I0407-1

SN 29343842

(C) Copyright 2004 ONKYO CORPORATION Japan. All rights reserved.



* 2 9 3 4 3 8 4 2 *